

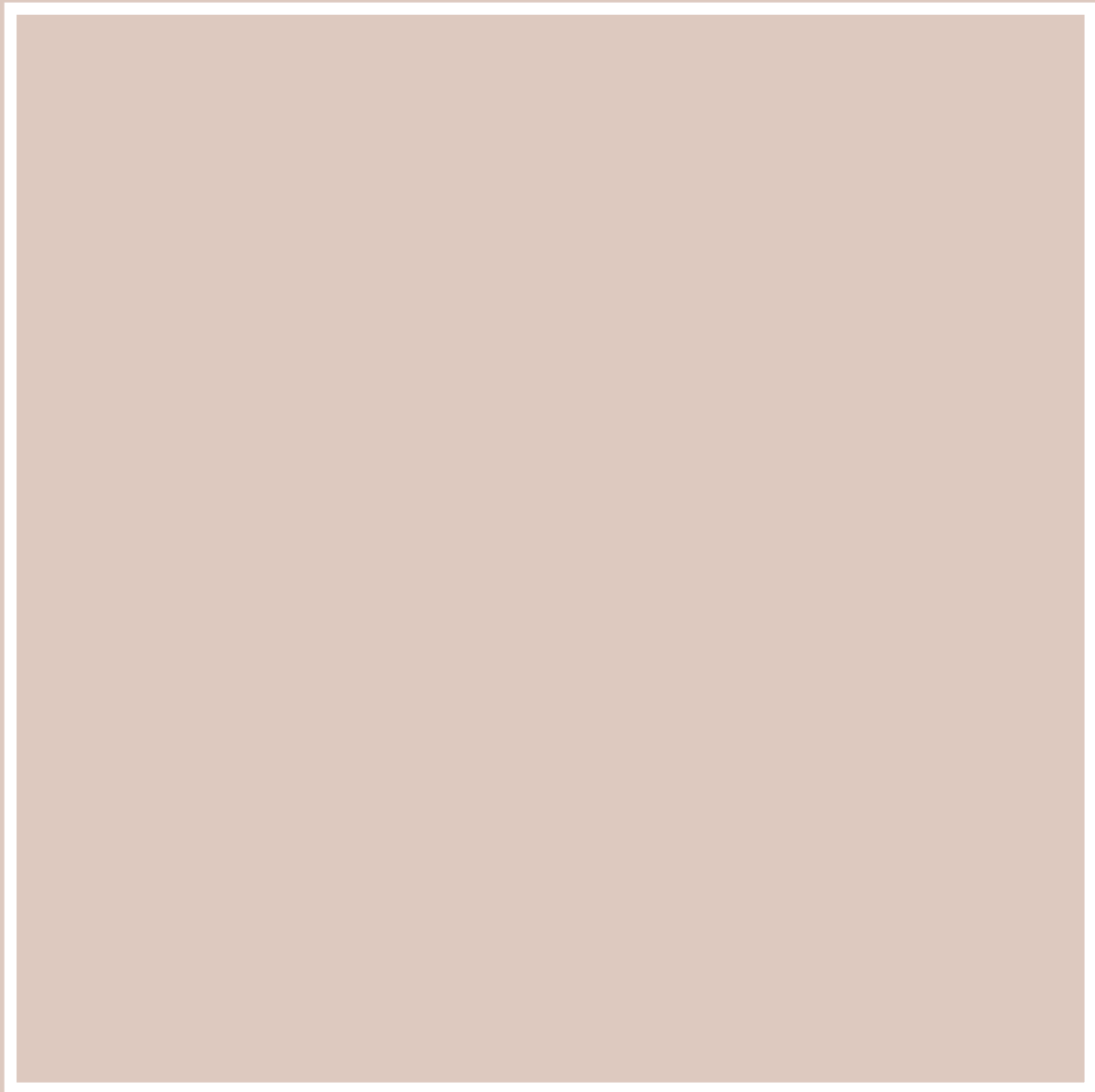

//////////////// COLLECTIONS  
2022 //////////////////////////////////////



**DE MAJO**



## AUTHENTIC ITALIAN TRADITION

SINCE 1947

DE MAJO is the name of our brand, but most importantly our last name.  
What you're about to witness is a real, 75-year-old story.



A visionary man named Guido de Majo, having escaped the atrocities of World War II, finds himself in Venice. Originally from Naples, Guido had a great spirit of adaptability, and a precise vision. In 1947, fascinated by the unique artistic tradition of our Venetian Lagoon, he founded a glass furnace with all the money he had, with the mission of changing Murano glass forever.

In fact, up until that time, only the finest and most ornate lighting pieces were made in Murano glass - Guido wanted to change that. He ramped up production, selecting only the most skilled artisans, and started producing *modern* Murano glass items - something unheard of.

Having established an entire new market for Murano glass, this gave the opportunity to shift artistic direction towards what we now call Design - which at the time was a "nameless attempt at something entirely new". This worked beautifully throughout the following decades.

Having changed Venetian history forever, Guido left his life's work into the hands of his son, Lucio de Majo.

Lucio had the ambitious will to return to traditions. He was born and bred in the context of glass furnaces. True to his origins, he decides to introduce traditional Venetian chandeliers alongside modern products in the DE MAJO collection. The impeccable level of craftsmanship offered by artisans made it possible, locating DE MAJO among the most prestigious artisanal brands of the Lagoon.

Having built quite a reputation, during the eighties and nineties DE MAJO delivered beautiful lighting pieces in many countries worldwide. This opened yet again another opportunity for DE MAJO, which alongside a "modern" and "traditional" collection, proposed a "bespoke" collection.

Since the start of the XXI century to this day, DE MAJO delivered over 1000 special, tailor made products in over 90 countries worldwide. Nowadays, Lucio's son Francesco de Majo represents the third generation of the de Majo family.

The same exact visionary ambition lives on, never sacrificing quality or attention to details, allowing new exciting chapters to be written about Murano glass.

Be like Guido, Change the world.

# INDEX



**ADAMAS**  
10



**AUGE**  
12

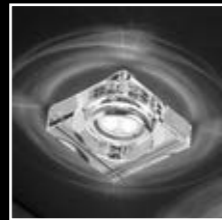

**TILE**  
14



**AKEMI**  
16



**ARCADE**  
18



**OXYGENE**  
68

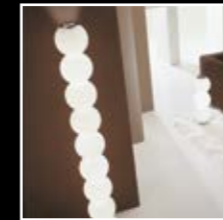

**PERLAGE**  
70



**PERONI**  
72



**POLI PO'**  
76



**STRATOSFERA**  
80



**BABOL**  
20



**BERNINI**  
24



**BICE**  
26



**CANNETTATA**  
28



**CARRÈ**  
32



**TAG**  
82



**TAU**  
84



**TOMMY**  
86



**XILO**  
88



**CHARLOTTE**  
34



**DIAPHANES**  
38



**DOME**  
42



**GEMMA**  
46



**GHOST**  
48



**I DISCHI**  
50



**KNOT**  
52



**LUMÈ**  
54



**MEMORY**  
58



**OTTO X OTTO**  
62

# INDEX



**ACQUA**  
90



**AFRIKA  
POM PON**  
92



**ARIA**  
94



**BUGIA**  
96



**CIOCCA**  
100



**NATURAL**  
142



**NOOR  
Collection**  
144



**PORTOFINO**  
156

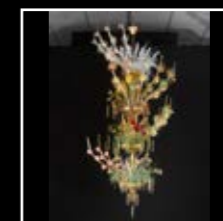

**QUATTRO  
STAGIONI**  
162



**RAPALLO**  
168



**COSMOPORA**  
104



**FLUTE**  
106



**FUOCO**  
108



**GARY**  
110



**GLACÈ**  
112



**ROSETO**  
170



**SARA**  
172



**TERRA**  
176



**TETRA**  
178



**VENEDIG  
POM PON**  
182



**GOUTTE**  
114



**I QUATTRO  
ELEMENTI**  
118



**ICE**  
120

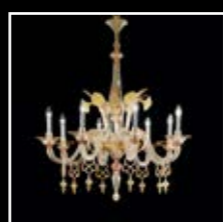

**IL MONDO  
DELLA LUNA**  
124



**L'ESTRO  
ARMONICO**  
126

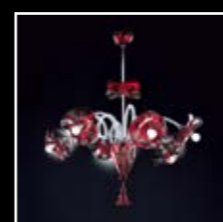

**VENEGIANO**  
184

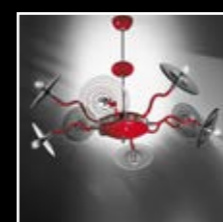

**VENUSSIANO**  
186

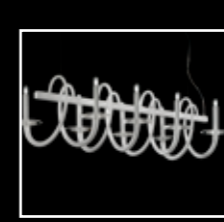

**VIVACE**  
188

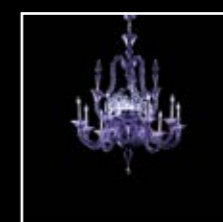

**VIVALDI**  
190



**2400**  
192



**LAGUNA  
PLANET**  
128



**LANTERNE**  
130



**LEVANTE**  
134



**MADEMOISELLE**  
136



**MADRIGALESCO**  
140



**2599**  
196



**2612**  
200



**6012**  
204



**6013**  
206



**6014**  
208

# INDEX

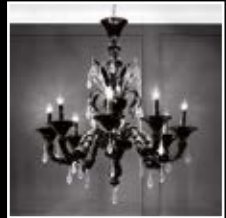

6099  
210



7055  
214



7056  
216



7060  
220



7061  
222



7093  
258



7095  
260



7096  
262



7098  
264



7099  
266



7063  
226



7065  
228



7067  
232



7074  
234

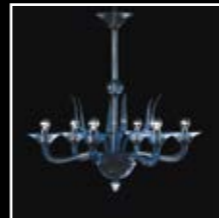

7077  
236



8000  
268



8001  
270



8002  
272



8003  
274



8004  
276



7079  
238



7080  
240



7081  
242



7082  
244



7084  
246



8006  
278



8010 8011 8012  
280

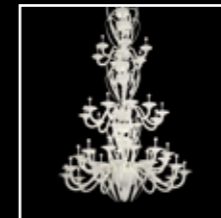

8020  
284



8080  
286



8089  
290



7085  
248



7086  
250



7087  
252



7088  
254



7092  
256



8090  
292



8097  
296



8099  
298



9001  
302



9002  
306

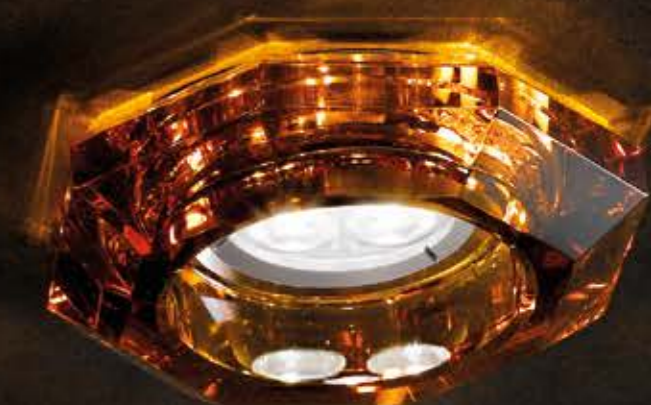

# An uniquely stylish spotlight.

Made for customers who wish to stand out and break the cliché of hidden spotlights.

The diamond cut glass piece is what makes this product precious and glamorous, adding a beautiful detail to the ceiling. Diameter 11 cm.

Custom finishes available upon request.

**ADAMAS**  
Design by Ufficio Stile de Majo

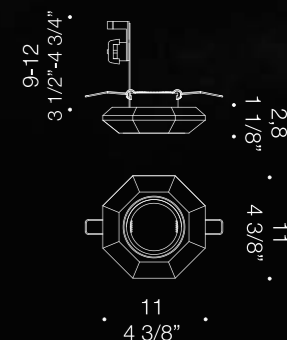

ADAMAS  
1xMAX 50W GU10  
Ceiling hole 7,5 cm diameter



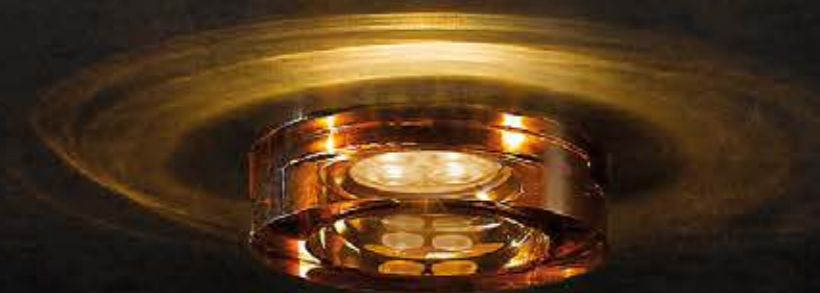
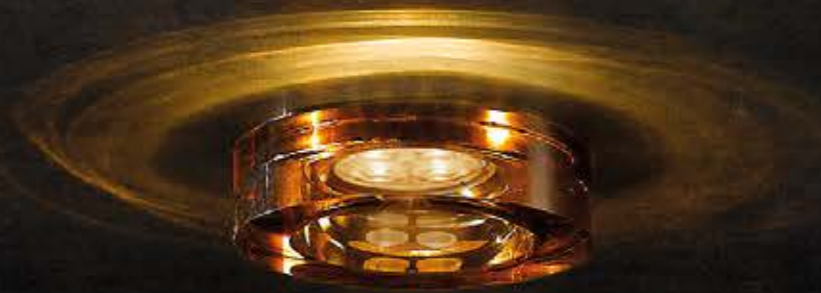

# A minimal spotlight featuring a thick glass ring as decoration.

**AUGE**  
Design by Ufficio Stile de Majo

Its formal and elegant look make it the perfect choice for virtually any interior, guaranteeing quality and stylishness. Diameter 11cm. Custom finishes available upon request.

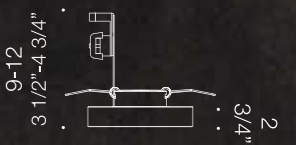

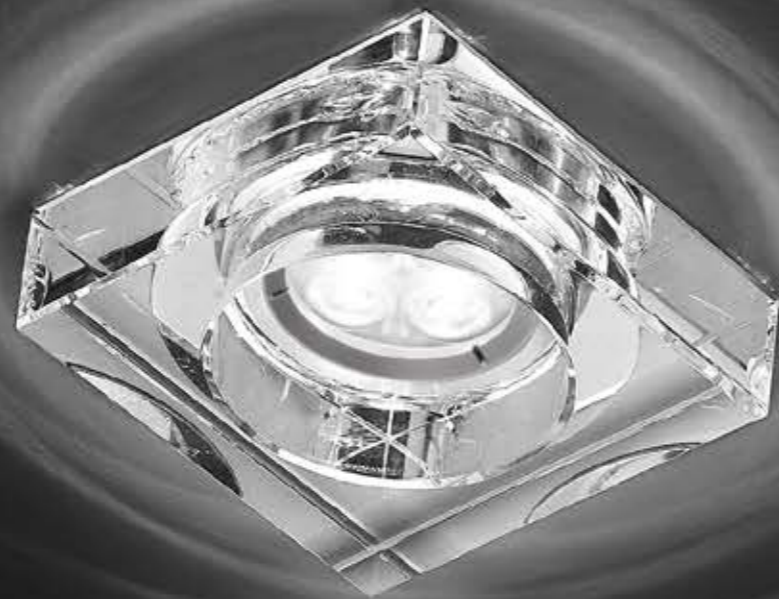

# The perfect choice for any interior.

Tile is a minimal spotlight featuring a thick glass slab with a square plan as decoration. Its formal and elegant look make it the perfect choice for virtually any interior, guaranteeing quality and stylishness. Diameter 11cm. Custom finishes available upon request.

**TILE**  
Design by Ufficio Stile de Majo

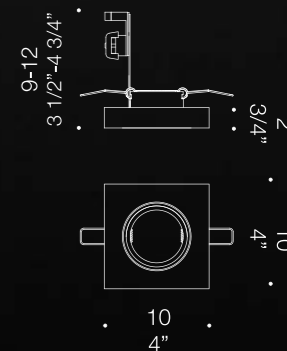

**TILE**  
1xMAX 50W GU10  
Ceiling hole 7,5 cm diameter





# Sleek and elegant suspension lamp.

Akemi is a sleek and elegant suspension lamp which features two main hand blown glass components. The milky white body is made out of layers of glass, resulting in a glossy finish - we call this "lattimo". The transparent upper section recalls a traditional Venetian decorative glass technique called "ballotton", which donates some more texture and refinement to the lamp all together. Akemi features CRI 90 LED technology, and lights up in both upward and downward directions, ensuring an evenly spread ambient lighting. Diameter 50cm, Height 42cm.

**AKEMI**  
Design by Nicola Grandesso

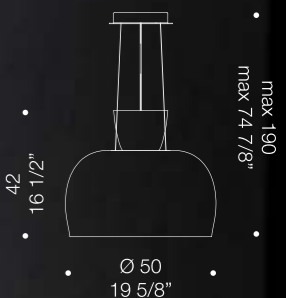

AKEMI  
Included led 2700K CRI 90  
1 x 25W 2500 lm +  
1 x 9W 900lm

CE  
#28  
E



# Northern-European aesthetic.

Arcade is a minimal suspension lamp inspired by Northern-European aesthetics. This beautifully crafted pendant features natural wood brackets and a custom made lampshade with a PMMA disk underneath. This highly textured product is a perfect match in an interior featuring natural wood furniture and textile details. A great choice for a variety of interiors. Diameter 50cm. Custom wood finishes available upon request.

**ARCADE**  
Design by Francesco de Majo

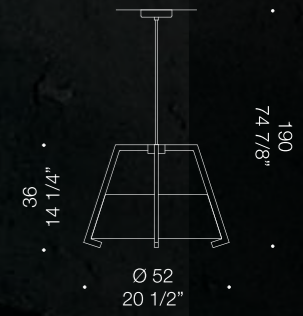

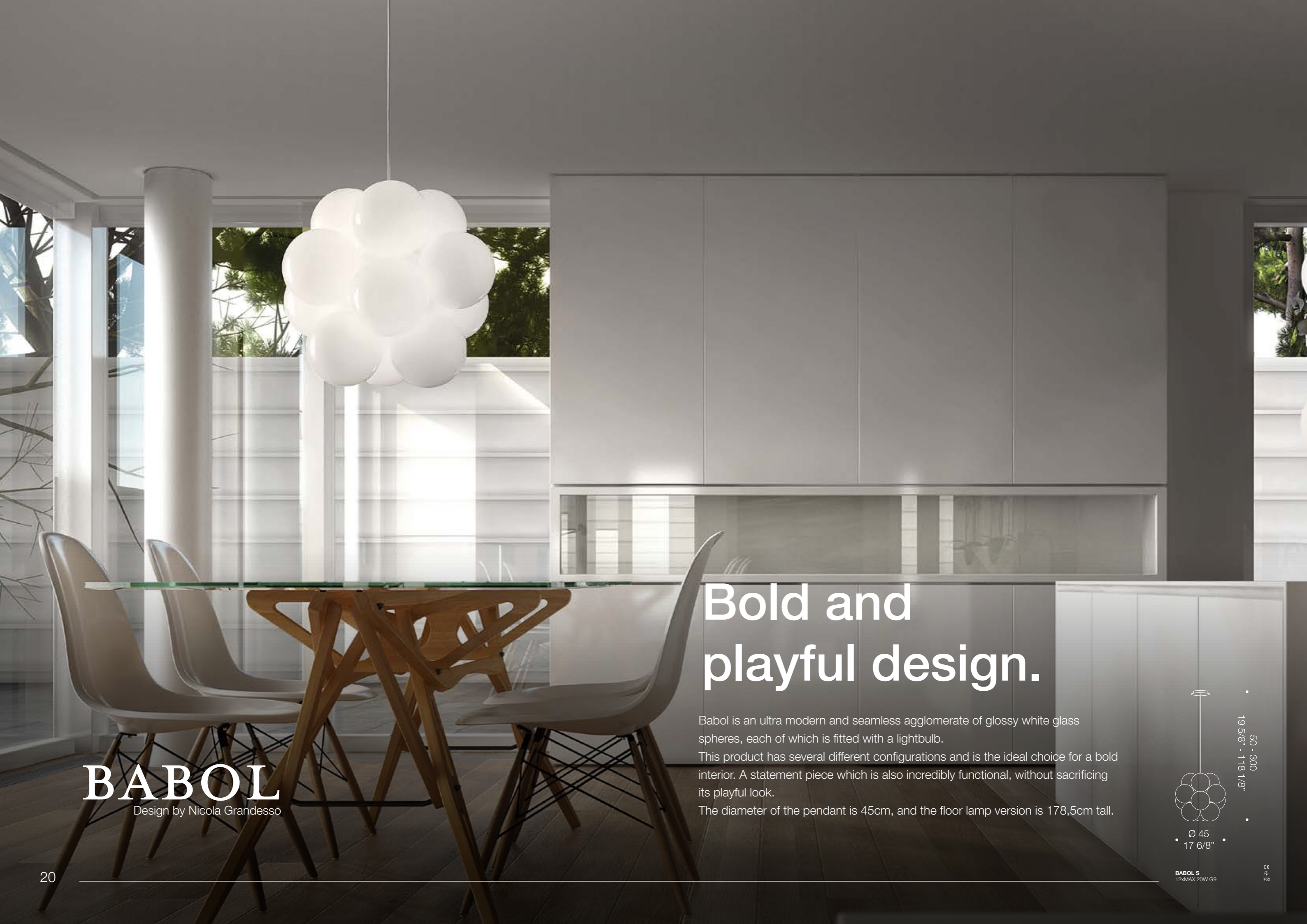

# Bold and playful design.

Babol is an ultra modern and seamless agglomerate of glossy white glass spheres, each of which is fitted with a lightbulb.

This product has several different configurations and is the ideal choice for a bold interior. A statement piece which is also incredibly functional, without sacrificing its playful look.

The diameter of the pendant is 45cm, and the floor lamp version is 178,5cm tall.

# BABOL

Design by Nicola Grandesso

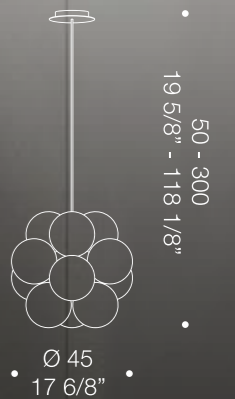

BABOL S  
12xMAX 20W G9

CE  
IP20

# BABOL

Design by Nicola Grandesso



46  
18 1/8"

Ø 45  
17 6/8"

BABOL P  
12xMAX 20W G9

Ø 45  
17 6/8"



178,5  
70 3/8"

BABOL R  
12xMAX 20W G9

Ø 45  
17 6/8"



62  
34 3/8"

BABOL T  
12xMAX 20W G9



# A classic yet industrial feeling.

Bernini, named after renowned Italian artist & sculptor, is a unique looking chandelier-style pendant light. The industrial yet deeply organic look of this piece makes it a great choice when in need of an accent piece. Beautifully designed and handcrafted, the intricacy of the curves intertwining is rendered effortless by the transparency and refraction of its glass arms. LED powered from the inner core. Diameter 90cm.

**BERNINI**  
Design by Raffaello Galiotto



**BERNINI**  
Included led 2700K CRI 90  
1 x 18W 1800 lm +  
1 x 9W 900lm



# BICE

Design by Alessandro Crosera



## Unique-looking ceiling lamp.

Bice is an unique-looking ceiling light featuring two very different pieces of glass, working together to achieve a sophisticated yet captivating look. This high performance LED lamp is a sleek choice for a minimal environment, without compromising some character. Diameter 30cm, Height 22cm.

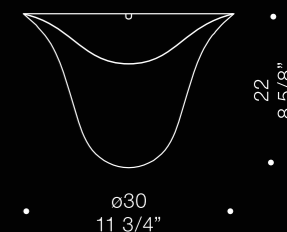



# Elegant and versatile design.

## CANNETTATA

Design by Massimo Iosa Ghini

Cannettata is a high performance LED-integrated suspension lamp designed by notorious architect Massimo Iosa Ghini. This elegant and sleek piece has become a staple thanks to its seamless design and versatility. An internal metal frame holds a masterfully crafted toroidal glass which has a vertical striped texture. The thickness of the glass creates a pleasant refraction when lit up, making Cannettata an everyday classic, ideal for homes and hospitality spaces. Diameter 42cm or 52cm.

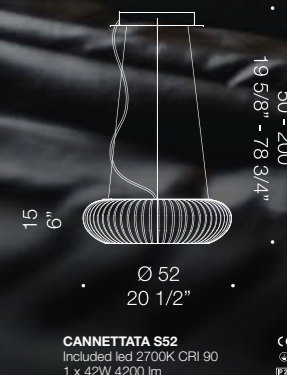



# CANNETTATA

Design by Massimo Iosa Ghini

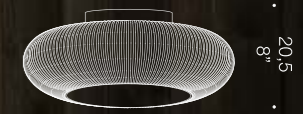

20.5  
8"

Ø 52  
20 1/2"

**CANNETTATA P52**  
Included led 2700K CRI 90  
1 x 42W 4200 lm

€  
€



18.5  
7 1/4"

Ø 42  
16 1/2"

**CANNETTATA P42**  
Included led 2700K CRI 90  
1 x 25W 2500 lm

€  
€

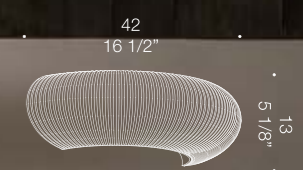

13  
5 1/8"

**CANNETTATA A42**  
Included led 2700K CRI 90  
1 x 16W 1300lm

€  
€



**CARRÈ**  
Design by Francesco Dei Rossi

# Highly refined minimal piece.

Carrè is perhaps the most simple yet versatile piece in our collection. The glassblowing process for this lamp requires a carefully crafted mould, shaped like a square with gently rounded edges. The minimal nature of this design makes this piece highly sought after for contract projects, as well as small or big installations or compositions. Glass width 14,5cm, Height 27cm or 42cm.

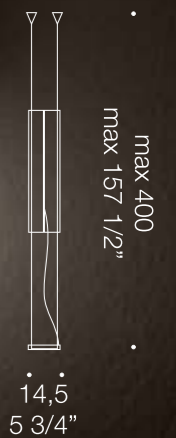

**CARRÈ SV**  
3xMAX 77W E27



**CARRÈ AG**  
2xMAX 77W E27



**CARRÈ AP**  
1xMAX 77W E27



# CHARLOTTE

Design by Luca Ferretto

## Industrial design with elegance.

Charlotte is a beautiful industrial style lamp, the body of which consists of a sleek crystal glass which is injected into a mold in order to prevent imperfections. The mechanical nature of its construction resonates with the design, making this piece one of our best sellers. Glass diameter 10cm.



13,5  
5 1/4"

Ø 10  
4"

CHARLOTTE P  
1xMAX 60W G9

CE  
E28

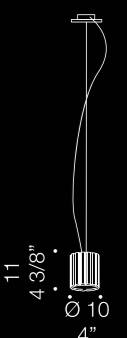

20 - 200  
7 7/8" - 78 3/4"

11  
4 3/8"  
Ø 10  
4"

CHARLOTTE S  
1xMAX 60W G9

CE  
E28

# CHARLOTTE

Design by Luca Ferretto



17  
6 5/8"

16,5  
6 1/2"

CHARLOTTE A  
1xMAX 80W G9



16  
6 1/4"

Ø 10  
4"

CHARLOTTE L  
1xMAX 80W G9

# DIAPHANES

Design by Valerio Cometti

## High-tech LED lamp.

Diaphanes is a high-performance LED lamp which comes in different formats. Its minimal design hides integrated LED technology, which guarantees high quality lighting and a long lasting product overall. This product was designed to look completely seamless, sleek and contemporary. Available in different configurations and sizes. Suspension diameter 30cm or 45cm. Floor lamp diameter 45cm. Table lamp diameter 30cm. Rechargeable desk lamp diameter 15cm.

Ø 45  
17 6/8"

35  
13 3/4"

175  
68 7/8"

DIAPHANES R  
Included led 2700K CRI 90  
1 x 35W 3500 lm +  
1 x 9W 900lm

CE  
#28  
E



# DIAPHANES

Design by Valerio Cometti



**DIAPHANES S45**  
 Included led 2700K CRI 90  
 1 x 35W 3500 lm +  
 3 x 3W 900lm

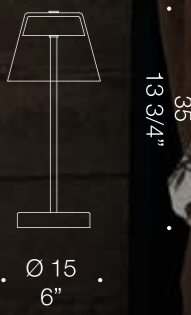

**DIAPHANES L**  
 Included led 3000K CRI 90  
 1 x 1.6W 160lm rechargeable battery



# Magical slim glass dome.

Dome is a sleek contemporary suspension lamp composed of a glass dome, and a slim lampshade. The way the glass dome hovers on top of the lampshade is somehow magical. This lamp features integrated LED technology, and thanks to a bottom plastic diffuser guarantees uniform and elegant light distribution. Diameter 38cm or 50cm. Height 18cm or 22cm.

# DOME

Design by Chiaramonte Marin

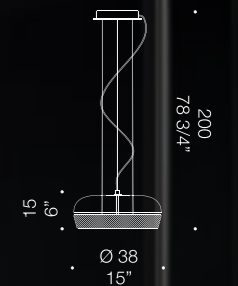

**DOME S38**  
Included led 2700K CRI 90  
1 x 25W 2500 lm

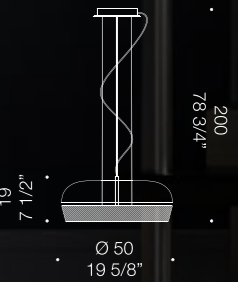

**DOME S50**  
Included led 2700K CRI 90  
1 x 35W 3500 lm



# DOME

Design by Chiaramonte Marin

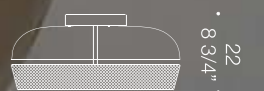

Ø 50  
19 1/2"

**DOME P50**  
Included led 2700K CRI 90  
1 x 33W 3500 lm

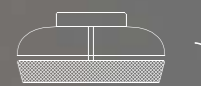

Ø 38  
15"

**DOME P38**  
Included led 2700K CRI 90  
1 x 25W 2500 lm



26      13  
10 1/4"      5 1/8"

**DOME A26**  
Included led 2700K CRI 90  
1 x 12W 1200 lm



**GEMMA**  
Design by Giovanni Barbato

# A best seller luxury piece.

Gemma has been a best seller for decades at DE MAJO. The simple lines and suspension mechanism effortlessly communicate sobriety with a touch of luxury. This suspension lamp features two glass pieces, which work together nicely, being adequately proportioned. Diameter 18cm.



GEMMA  
1xMAX 77W E27

CE  
E27





# Smart modern suspension lamp.

Ghost is a stylish modern suspension lamp that features two main glass components and a minimal structure. The inner glass sphere is milk white, while the outer glass dome is available in different colours. This lamp allows the possibility to regulate the height of the glass dome component, in order for it to adjust at any height along the central canopy. Perfect for mixing and matching, this piece is a very commercial and smart choice for contract and hospitality interiors.

# GHOST

Design by Giovanni Barbato



**GHOST S19**  
Included led 2700K CRI 90  
1 x 9W 1400 lm



**GHOST S23**  
Included led 2700K CRI 90  
1 x 9W 1400 lm



# Versatile modular composition.

"I DISCHI" composed by several handmade glass "disks", each of which displays a singular, typically Venetian glass working technique - the perfect link between tradition and modernity. Carefully handmade, this product is an elegant, subtle, but incredibly rich accent piece for residential and hospitality projects. Available in two different standard configurations featuring clear glass, this product can also be adjusted and engineered to perfectly adjust to a wide variety of design situations.

# I DISCHI

Design by Francesco Dei Rossi

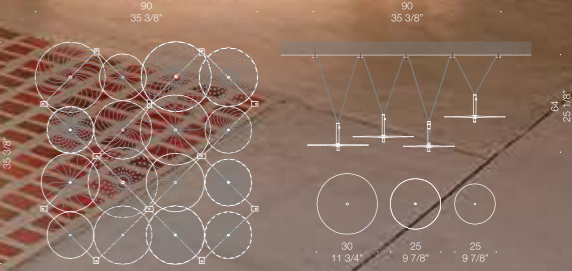

I DISCHI  
6xMAX 20W G4 12V

CE  
E28



# KNOT

Design by Francesco Dei Rossi



## Compact light piece.

Knot is a versatile suspension-style chandelier featuring 3 arms which convolute into an unique well-proportioned agglomerate. This handmade piece is highly customisable due to its modular nature. Each arm can be handpicked from a variety of traditional Murano glass working techniques, as well as the glass lampshade element which hides the lightbulb. Perfect in a variety of contemporary and classical interiors, Knot makes the perfect choice when in need of a tight light spot with some glamour.



**KNOT P**  
3xMAX 60W G9

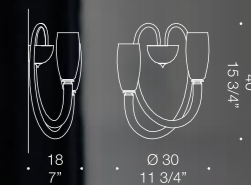

**KNOT A2**  
2xMAX 60W G9



**KNOT S**  
3xMAX 60W G9

**LUMÈ**  
Design by Nicola Grandesso

# A classic with a modern twist.

Lumè is a simple and traditionally inspired glass lampshade with a touch of modern design. It comes in different finishes including the popular "lattimo" white glossy finish. This model has different configuration options, and is a very versatile choice for any residential or hospitality space. Glass diameter 15cm, 35cm or 50cm.



LUMÈ R1  
1xMAX 77W E27

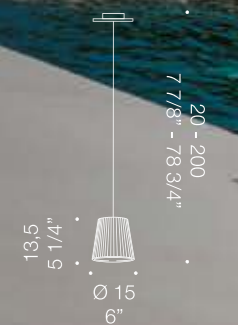

LUMÈ  
1xMAX 46W E14

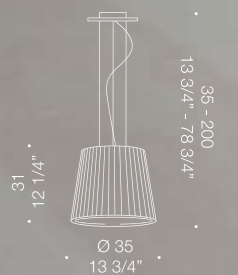

LUMÈ S1  
1xMAX 77W E27

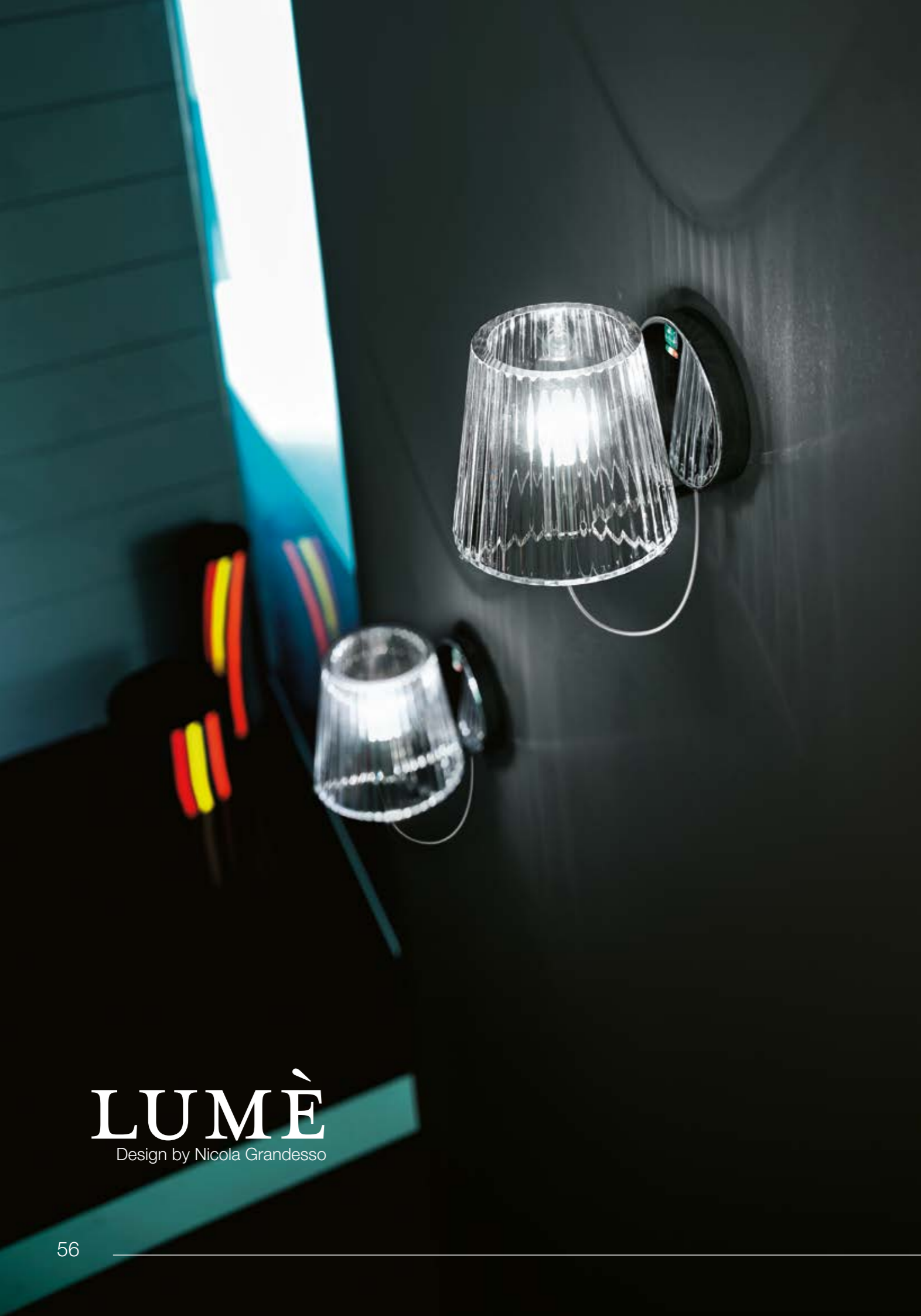

# LUMÈ

Design by Nicola Grandesso



**LUMÈ T1**  
1xMAX 77W E27

CE  
E27



**LUMÈ L**  
1xMAX 46W E14

CE  
E14



**LUMÈ A2**  
2xMAX 46W E14

CE  
E14



**LUMÈ A1**  
1xMAX 46W E14

CE  
E14



# MEMORY

Design by Lucio de Maio

## Iconic italian masterpiece.

Memory is probably the most iconic product at DE MAJO. There have been dozens of versions of this beautiful sleek lamp. It comes with a metal structure available in different finishes, and a masterfully handblown glass piece. Diameter 16cm, 19cm, or 28cm, Height 21cm, 28,5cm or 40cm.

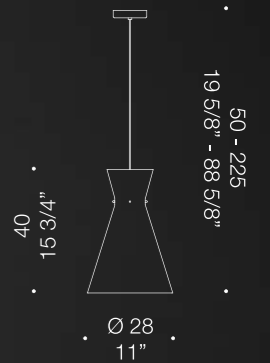

MEMORY SL  
1xMAX 77W E27

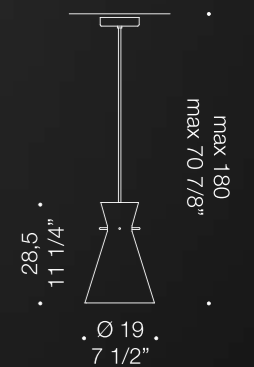

MEMORY SG  
1xMAX 77W E27

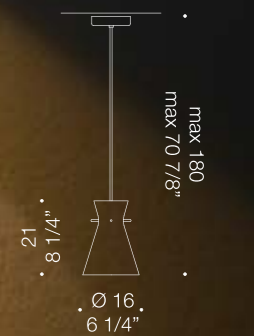

MEMORY SP  
1xMAX 77W E27



# MEMORY

Design by Lucio de Majo

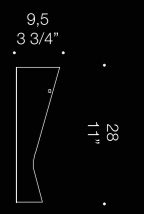



# Mid-century aesthetics.

Otto x Otto is a lighting product inspired by mid-century aesthetics. This versatile lamp is composed by eight flawless glass squares which are each 1 cm thick. The shapes created by playing with these small glass components make this piece a playful yet very elegant piece. There are several configurations available with this design, including a table lamp, and a beautiful grand chandelier. The modern and well proportioned look of otto x otto has fascinated many clients during the past decade, making it one of our best sellers. Dimensions vary according to configuration.

# OTTO X OTTO

Design by Francesco De' Rossi

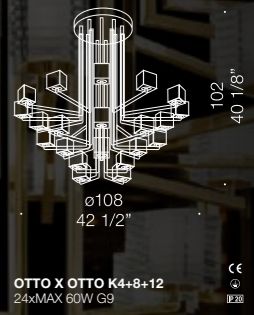

OTTO X OTTO K4+8+12  
24xMAX 60W G9

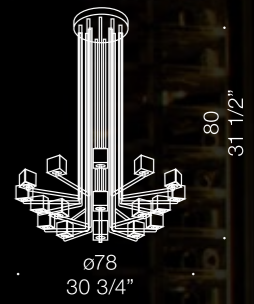

OTTO X OTTO K8+8  
16xMAX 60W G9

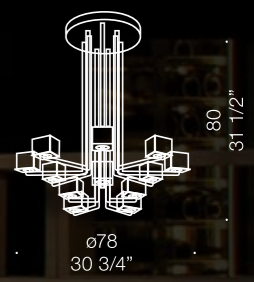

OTTO X OTTO K4+8  
12xMAX 60W G9

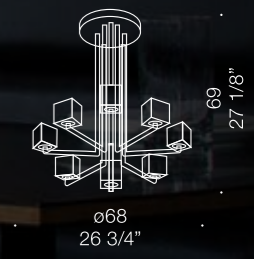

OTTO X OTTO K8  
8xMAX 60W G9





# OTTO X OTTO

Design by Francesco Dei Rossi

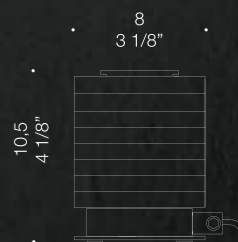

**OTTO X OTTO L**  
1x MAX 60W G9



**OTTO X OTTO A**  
1x MAX 60W G9

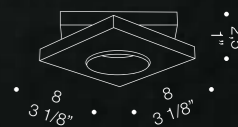

**OTTO X OTTO F**  
1x MAX 35W GY6,35 12V





# OTTO X OTTO

Design by Francesco Dei Rossi

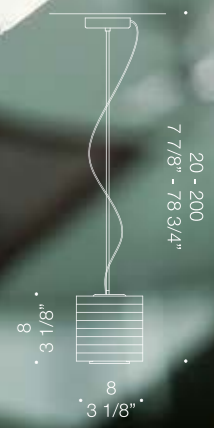

OTTO X OTTO S  
1xMAX 60W G9



OTTO X OTTO P  
1xMAX 60W G9





# OXYGENE

Design by Francesco Dei Rossi

## An exquisite modern classic.

Oxygene is a modern table lamp which is handblown with ancient Venetian techniques. This quirky yet elegant product has been a staple at DE MAJO. The paradox between a modern look and a traditional construction method is very significant for our brand, and symbolises the thriving contemporary taste without compromising our heritage. Diameter 22cm or 35cm, Height 28cm or 45cm

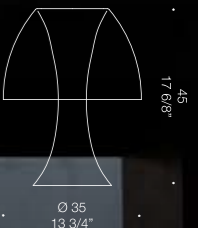

OXYGENE T  
1xMAX 77W E27 silvered dome

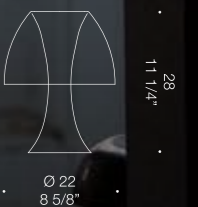

OXYGENE L  
1xMAX 46W E14 silvered dome

# PERLAGE

Design by Oriano Favaretto

## Contemporary pop floor lamp.

Perlage floor lamp features an extraordinarily big piece of glass composed of 9 blown spheres. The contemporary look is often referred to as playful and homely. This accent piece not only blends in perfectly with a multitude of interiors, it is also a high performance lamp designed to light up uniformly along its volume. Diameter 35cm, Height 182cm.



# PERONI

Design by Ufficio Stile de Majo

## Heritage, redefined.

Peroni is a classic. Designed over 50 years ago, DE MAJO still produces a modern and refined version of the original to this day. Sleek and simple, this product is among the most versatile. Available in different metal finishes, the frame holds a masterfully blown glass piece. Diameter 14cm or 16cm, Height 30cm or 40cm.

PERONI S16  
1xMAX 77W E27

40  
15 3/4"  
Ø 16  
5 1/2"

30  
11 3/4"  
Ø 14  
5 1/2"

PERONI S14  
1xMAX 77W E27

Ø 14  
5 1/2"



# PERONI

Design by Ufficio Stile de Majo

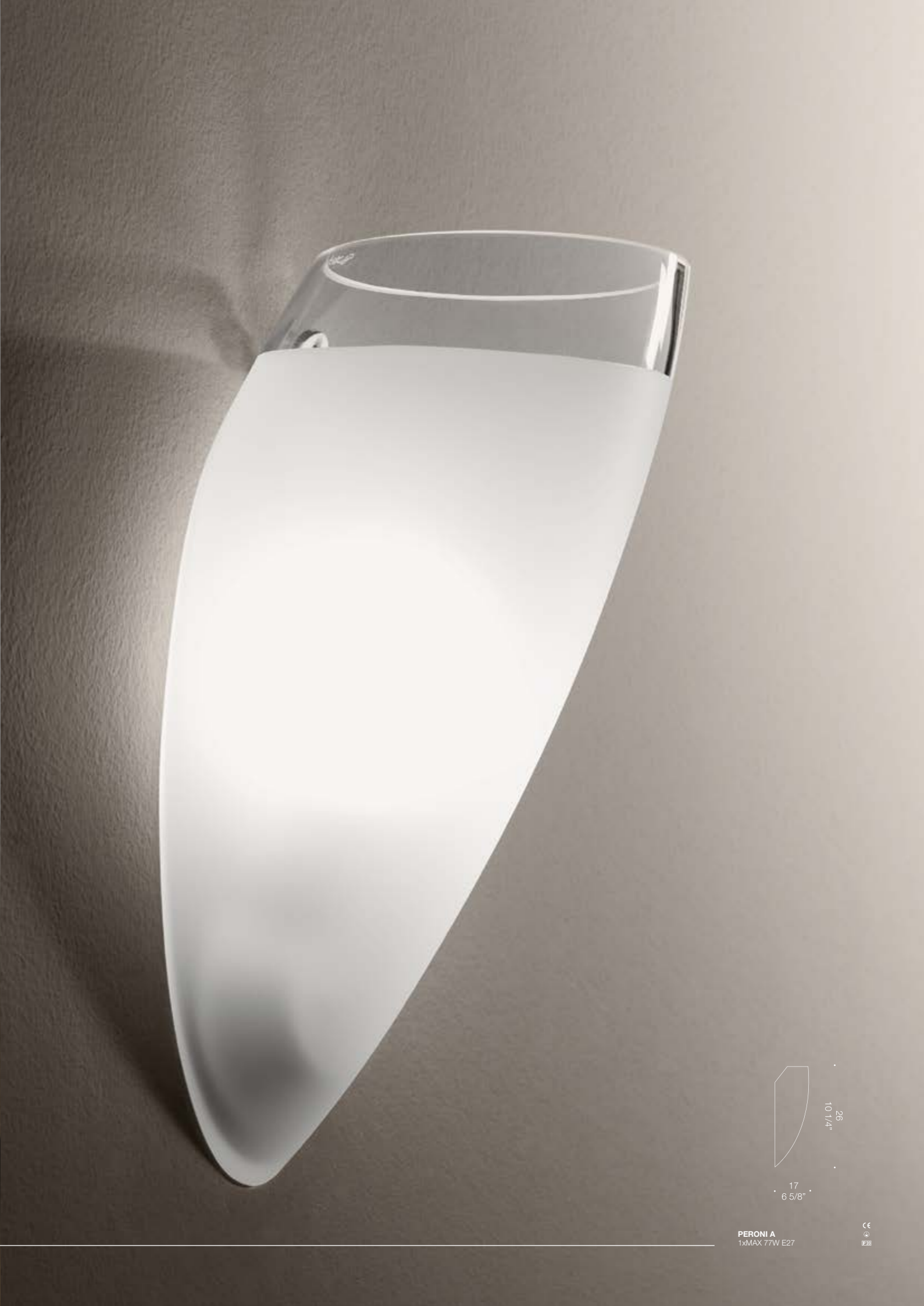



# 60's visionary design.

At the time, this product was something nobody had ever seen before, and contributed to building a reputation for our brand. Uniquely shaped handblown glass shades are fixed to adjustable metal arms, creating a playful and quirky statement piece. This lamp comes in a variety of configurations and sizes.

**POLI PO'**  
Design by Oriano Favaretto

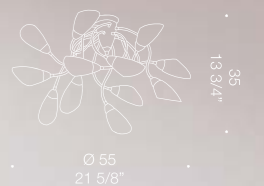

35  
13 3/4"

Ø 55  
21 5/8"

**POLI PÒ P12/A12**  
12xMAX 46W E14



35  
13 3/4"

Ø 55  
21 5/8"

**POLI PÒ P8/A8**  
8xMAX 46W E14

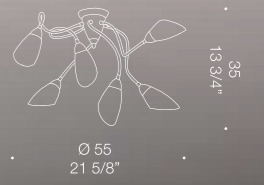

35  
13 3/4"

Ø 55  
21 5/8"

**POLI PÒ P6/A6**  
6xMAX 46W E14

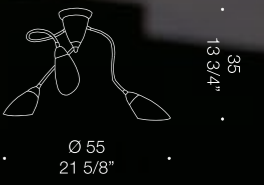

35  
13 3/4"

Ø 55  
21 5/8"

**POLI PÒ P3/A3**  
3xMAX 46W E14

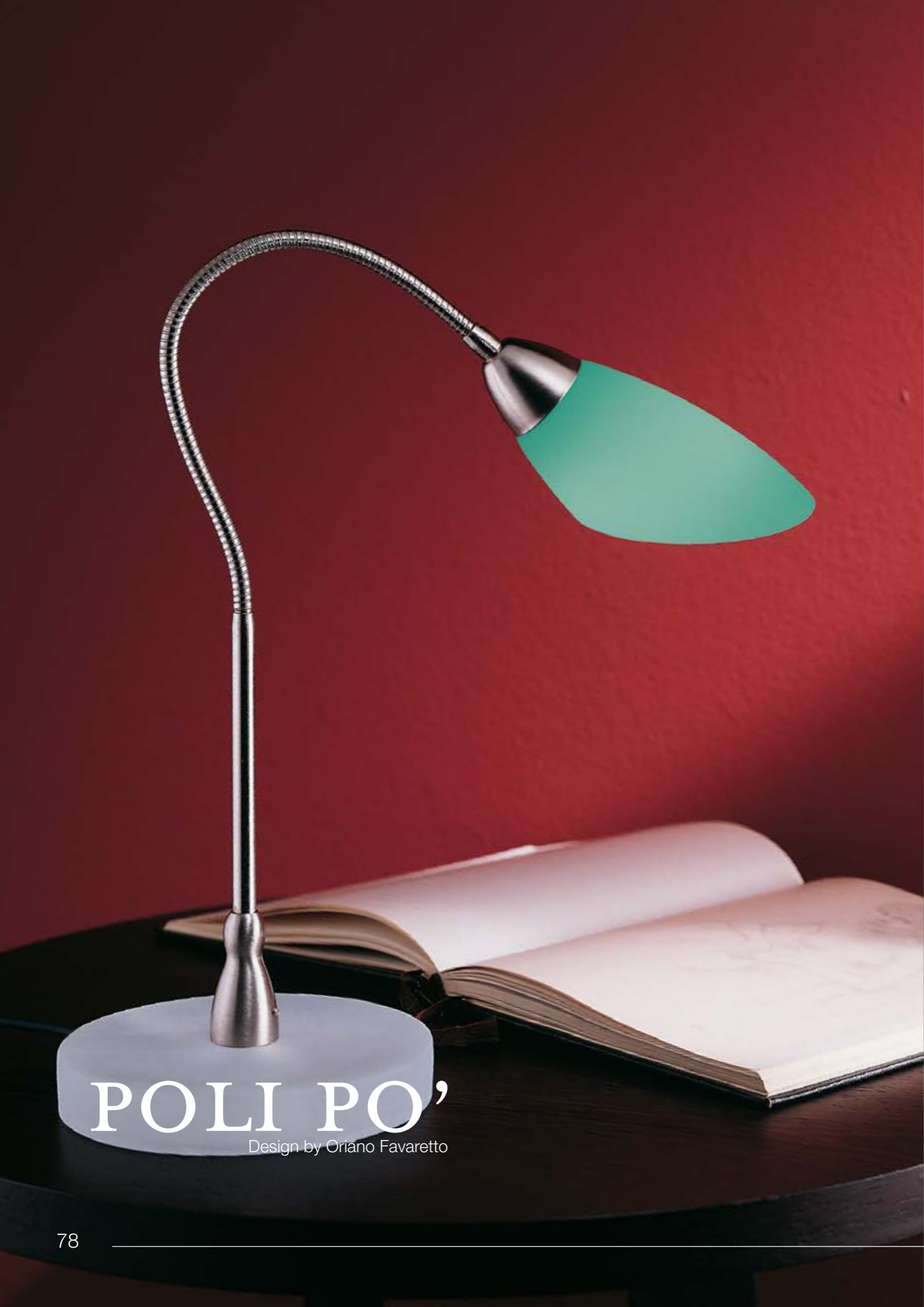

**POLI PO'**  
Design by Oriano Favaretto



**POLI PO A2**  
2xMAX 46W E14

CE  
#28

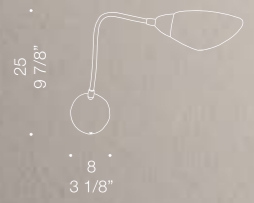

**POLI PO A1**  
1xMAX 46W E14

CE  
#28



**POLI PO L**  
1xMAX 46W E14

CE  
#28





# STRATOSFERA

Design by Oriano Favaretto

## Space-age inspired design

Stratosfera is a lamp inspired by space-age. The sleek diagonal patterns on this huge handblown sphere resemble the shapes of a planet. Finished in a glossy white triple-layer glass, this piece is a strong statement for home decor. Available in different configurations and sizes ranging from a diameter of 25cm to 50cm.



STRATOSFERA S25  
1xMAX 77W E27 tubolar



STRATOSFERA S40  
1xMAX 77W E27 tubolar



STRATOSFERA S50  
1xMAX 77W E27 tubolar



STRATOSFERA T40  
1xMAX 77W E27 tubolar



STRATOSFERA L25  
1xMAX 77W E27 tubolar

CE

CE

CE

CE

CE



# Natural, warm feeling light.

The concept behind Tag is significantly expressed by the encounter of two very different materials (glass and wood) working together in harmony. The stylish look and the sophisticated finishes makes this lamp the perfect choice when matching other furniture. Great for both residential and hospitality projects, there is a certain kind of warmth conferred to this piece thanks to the use of natural wood - resulting in a sustainable design choice. Diameter 30cm.

# TAG

Design by Francesco de Majo

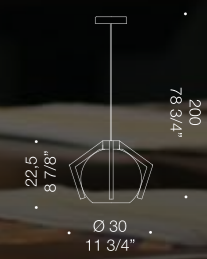

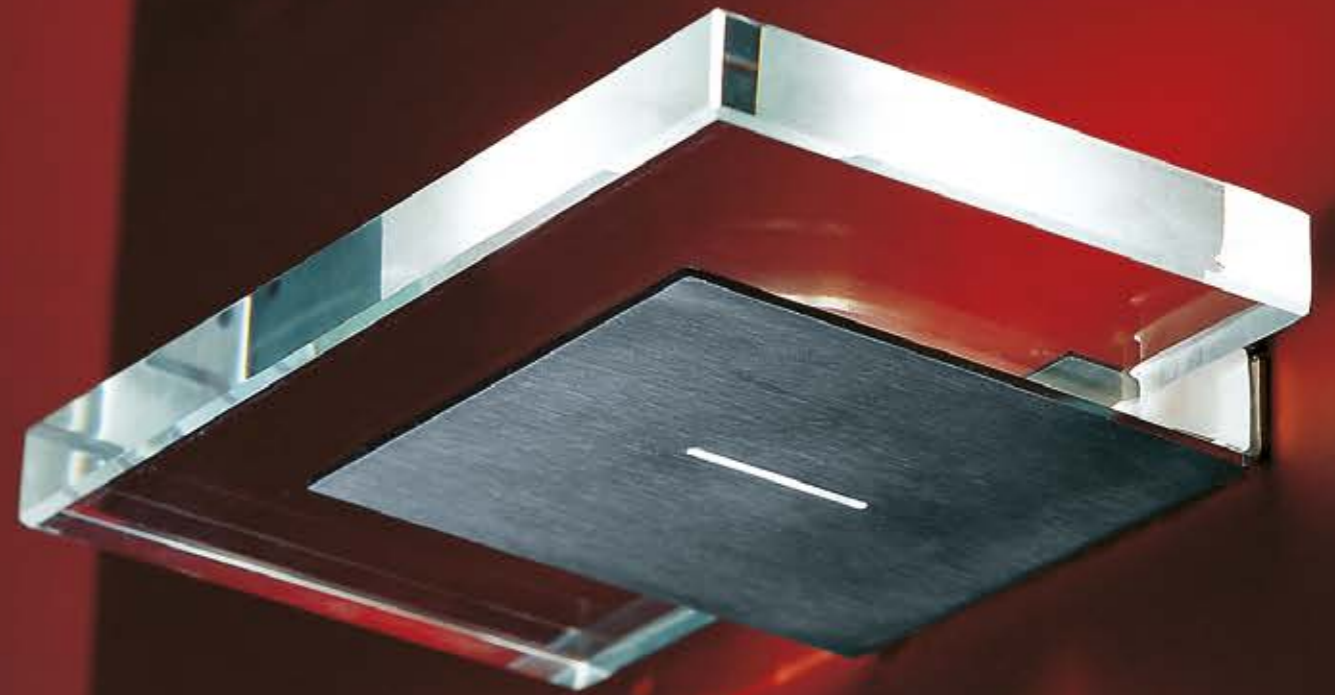

## Elegant, sleek wall lamp.

Tau is a minimal and sleek wall lamp designed to blend into any high-end, sophisticated interior. It forms a narrow light beam on the wall, which adds a touch of elegance. A product which was thought for contract, but also loved in residential projects. Width 20cm.

**TAU**  
Design by Ufficio Stile de Majo

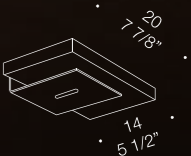



# Beautiful casual suspension lamp.

Tommy is a beautiful and casual suspension lamp featuring a handblown glass lampshade and a beautifully crafted metal structure which is available in multiple finishes. This design originates from the 70s and we consider this piece to be a universal, easy product with loads of character and a slight industrial feel. Diameter 37cm.

**TOMMY**  
Design by Ufficio Stile de Majo





**XILO**  
Design by Ufficio Stile de Majò

# Simple, universal design.

Xilo is a simple yet captivating lamp featuring a glass tube with a sanded ornate section which shields the user from direct light. This design is simple and universal and has remained unchanged at DE MAJO for decades. Diameter 10cm or 13cm.

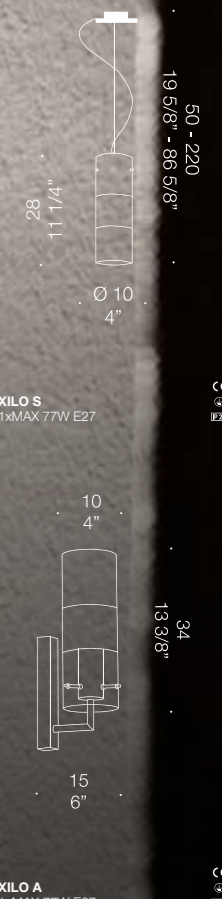

# ACQUA

Design by Roberto Assenza - Francesco Dei Rossi

## Water inspired chandelier.

Acqua is an unique and beautifully crafted chandelier inspired by water. Featuring exclusive pendants which confer a sense of motion to this piece, the overall look of this product is truly what we define a "statement piece". Handmade in Murano, this chandelier is part of a series called "The Four Elements". Diameter 100cm. Highly customisable.



Ø 100  
39 3/8"



# AFRIKA POM PON

Design by Maria Grazia Rosin

## Exotic feel art-piece.

This quirky, playful, yet precious chandelier was designed by Venetian artist Maria Grazia Rosin. The colours and patterns resemble the savannah, conferring a touch of exotic feel to this accent chandelier. Handmade in Murano. Diameter 86cm. Highly customisable.



Ø 86  
33 7/8"

92



# Unique handmade chandelier.

Aria is an unique and beautiful crafted chandelier inspired by air and its light, vanishing properties. This design is very captivating and effortlessly elegant. Handmade in Murano, this chandelier is part of a series called "The Four Elements". Diameter 100cm. Highly customisable.

# ARIA

Design by Roberto Assenza - Francesco Dei Rossi

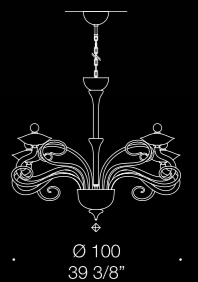

90  
35 3/8"

Ø 100  
39 3/8"

ARIA K8  
8xMAX 46W E14

CE  
E238





**BUGIA**  
Design by Roberto Assenza

# Mid-century style masterpiece.

Bugia is a precious, sophisticated chandelier with a captivating design. Silk lampshades and matching glass accents are available in different colours. This design is inspired by tradition, with a touch of chic and glamour. Great for an elegant mid-century style interior. Dimensions and configurations vary. Highly customisable.

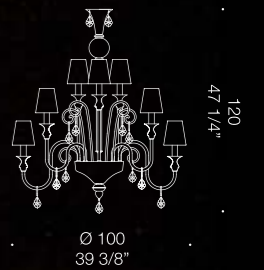

120  
47 1/4"

Ø 100  
39 3/8"

**BUGIA K16**  
16xMAX 46W E14

CE  
E14

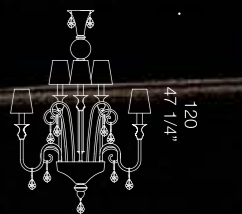

120  
47 1/4"

Ø 80  
31 1/2"

**BUGIA K12**  
12xMAX 46W E14

CE  
E14



120  
47 1/4"

Ø 70  
27 1/2"

**BUGIA K8**  
8xMAX 46W E14

CE  
E14



# BUGIA

Design by Roberto Assenza



**BUGIA T4**  
4xMAX 46W E14



**BUGIA T1**  
1xMAX 46W E14

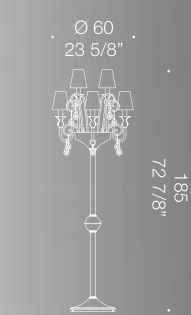

**BUGIA R8**  
8xMAX 46W E14



**BUGIA A3**  
3xMAX 46W E14

CE

CE

CE

CE

# CIOCCA

Design by Francesco dei Rossi

## Artisanal, elegant ribbon design.

Ciocca is a chandelier with an elegant, unique design. It is composed of a metal structure which holds numerous handmade glass "ribbons". Skilled glassblowers pull and texturise these ribbons, creating a sinuous and organic design altogether. There are numerous configurations for this product, ranging from suspension lamp, to a wall lamp version. Diameter 55cm, 68cm, 95cm or 120cm. Height varies according to configuration. Custom dimensions and colours available.



CIOCCA S33  
33xMAX 33W G9



CIOCCA S16  
16xMAX 33W G9



CIOCCA S13  
13xMAX 33W G9



CIOCCA S6  
6xMAX 33W G9



CIOCCA S4  
4xMAX 60W G9



**CIOCCA**  
Design by Francesco dei Rossi



**CIOCCA A1**  
1xMAX 60W G9

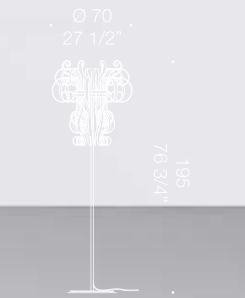

**CIOCCA R**  
1xMAX 150W E27



# COSMOSPORA

Design by Maria Grazia Rosin

## Handblown luxury pendant light.

Cosmospora is an unique pendant light. An accent piece for quirky, playful yet luxurious homes or hospitality spaces. Each piece is handblown individually forming an agglomerate of organic glass shapes. Each glass element is attached to a movable metal pipe, which can be played around with in order to create the desired shape. A hands-on product which never ceases to amuse. Diameter 70cm or 200cm.

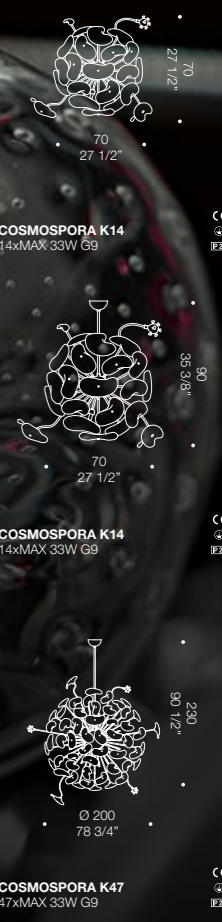



# FLUTE

Design by Hangar Design Group

## Champagne glass chandelier.

Flute is a stylish, modern style glass chandelier. Handmade in Murano, this piece is not a traditional design. This piece was intentionally thought to please a niche clientele who loves mid-century modern style. The vintage lines and classic colours make this piece a sober yet sophisticated chandelier for everyday use. Diameter 65-118 cm according to configurations.

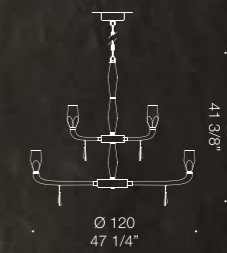

**FLUTE K12+6**  
18xMAX 33W G9

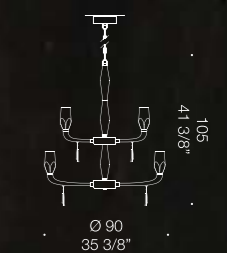

**FLUTE K8+6**  
14xMAX 33W G9

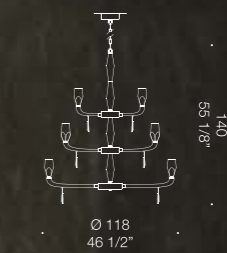

**FLUTE K12+8+6**  
26xMAX 33W G9



**FLUTE K12**  
12xMAX 33W G9



**FLUTE K8**  
8xMAX 33W G9

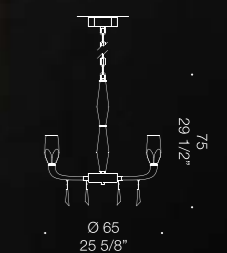

**FLUTE K6**  
6xMAX 33W G9

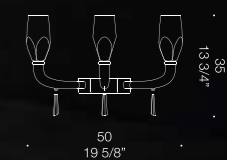

**FLUTE A3**  
3xMAX 33W G9

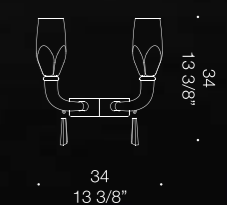

**FLUTE A2**  
2xMAX 33W G9





# FUOCO

Design by Roberto Assenza - Francesco Dei Rossi

## Fire inspired chandelier.

Fuoco is an unique and beautifully crafted chandelier inspired by fire. The combination of different shades of red and 24k gold leaf embedded into glass pieces almost make this piece look alive. Handmade in Murano, this chandelier is part of a series called "The Four Elements". Diameter 100cm. Highly customizable.



90  
35 3/8"

Ø 100  
39 3/8"

FUOCO K8  
8xMAX 46W E14



**GARY**  
Design by Francesco Dei Rossi

# Modern and sleek lighting piece.

Gary is an extremely modern and sleek lighting piece which can be ceiling mounted, or used as a pendant light. Highly modular, this piece is minimal and features a never seen before design. Diameter 70cm.







**GLACÉ**  
Design by Hangar Design Group

## Liberty style chandelier.

Glacé is handmade in Murano, and designed to be elegant, sober, minimal. The clean lines are extremely well proportioned and they create a grand volume without cluttering. This piece features glass lampshades and “rigadin ritorto” arms. Dimensions 110cm or 130cm.





# GOUTTE

Design by Nicola Grandesso

## Beautiful rain inspired piece.

Goutte is a beautiful chandelier inspired by rain itself. It features smooth arms, luxurious lampshades and a series of glass "droplets" which replicate raindrops. A strong concept which elegantly unfolds in this crowded yet majestic creation. It comes in numerous configurations, depending on how many light spots you desire. Diameter min. 90cm - max. 120cm

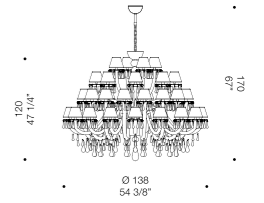

**GOUTTE S44**  
44xMAX 46W E14

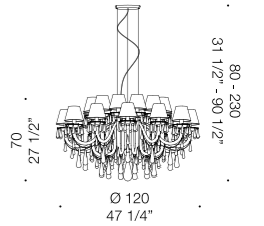

**GOUTTE S24**  
24xMAX 46W E14

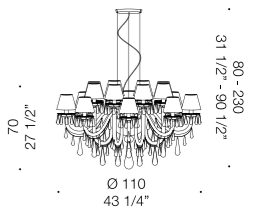

**GOUTTE S16**  
16xMAX 46W E14

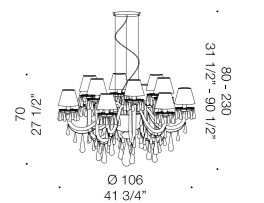

**GOUTTE S12**  
12xMAX 46W E14

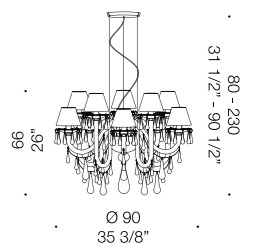

**GOUTTE S10**  
10xMAX 46W E14

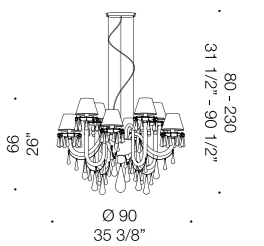

**GOUTTE S8**  
8xMAX 46W E14



# GOUTTE

Design by Nicola Grandesso



GOUTTE A3  
3xMAX 46W E14

CE  
EN  
1236

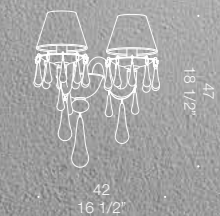

GOUTTE A2  
2xMAX 46W E14

CE  
EN  
1236



# I QUATTRO ELEMENTI

Design by Roberto Assenza - Francesco Dei Rossi



## Exclusive art piece.

This majestic chandelier is absolutely unique in its form and concept. Four chandeliers in one, each representing an element, make this product an exclusive and captivating accent piece, installation style. Water, Air, Fire and Earth are each represented by a section of this chandelier. Highly customizable, this piece represents extreme luxury.



250  
98 3/8"

Ø 165  
65"

I QUATTRO ELEMENTI K40  
34xMAX 46W E14 +  
6xMAX 33W G9

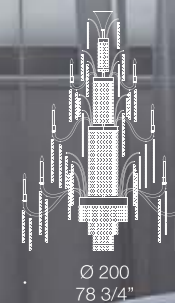

ICE K84  
57xMAX 46W E14 +  
27xMAX 20W G9



ICE K12  
12xMAX 46W E14 +  
9xMAX 20W G9

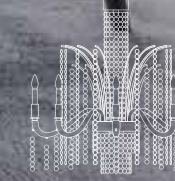

ICE K8  
8xMAX 46W E14 +  
6xMAX 20W G9

# Venetian boheme luxury chandelier.

Ice is a luxurious, highly ornate chandelier which represents the union between Venetian tradition and boheme style, thanks to the Swarovski crystal pendants. The chic look and its precious components are this chandelier a highly sought after piece in our collection. The highly customisable nature of this piece makes it easy for interior designers and architects to approach this product and request further customizations. Available in different configurations and sizes.

**ICE**  
Design by Nicola Grandesso



**ICE**  
Design by Roberto Assenza

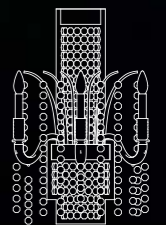

70  
27 1/2"

Ø 45  
17 6/8"

ICE A3  
3xMAX 46W E14 +  
4xMAX 20W G9

CE

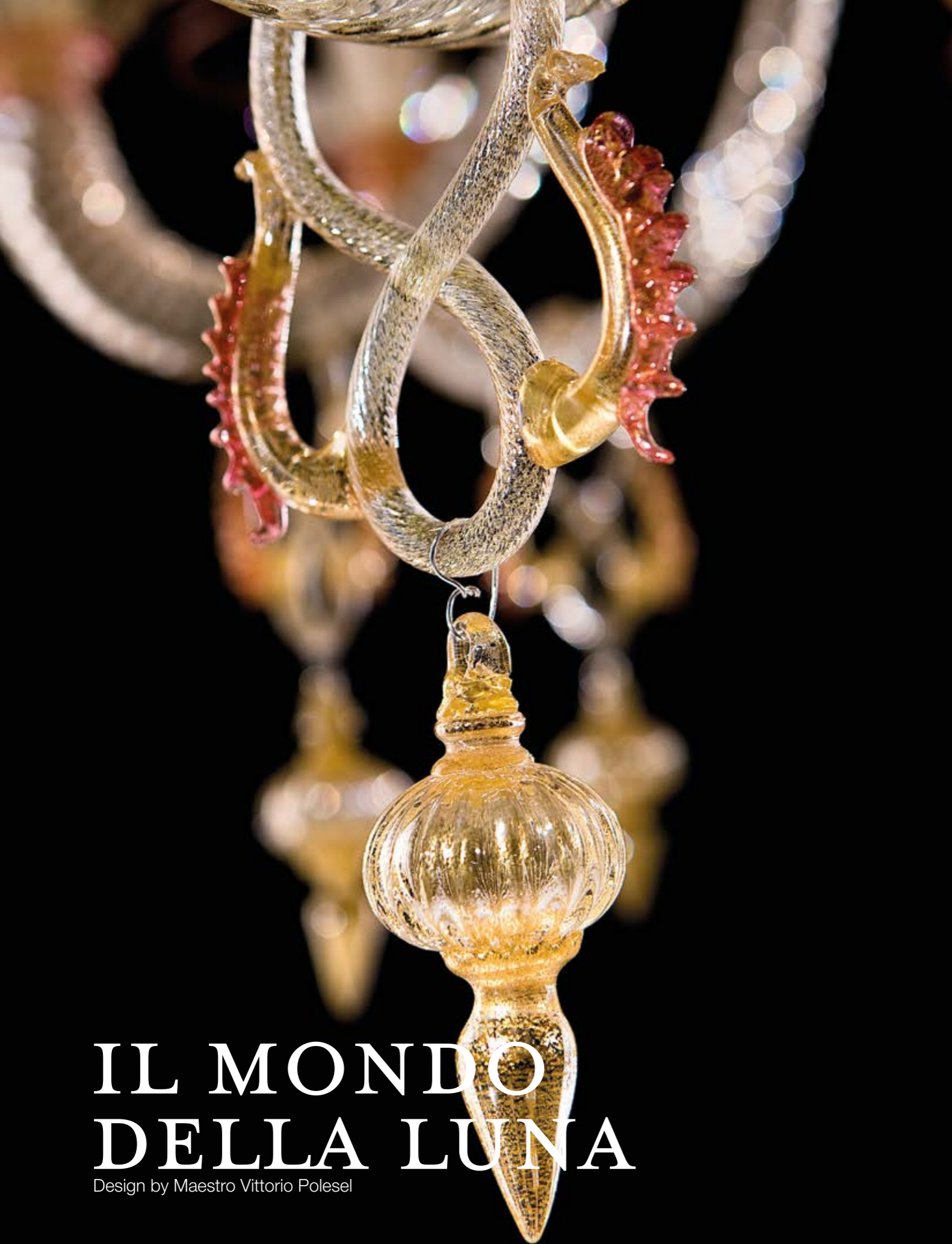

# IL MONDO DELLA LUNA

Design by Maestro Vittorio Polesel



## A Venetian masterpiece.

Il Mondo Della Luna literally translates to "Moon World". This piece is an authentic handmade masterpiece which really shows the incredibly high level of craftsmanship thanks to rich, intricate and captivating details. Highly customizable, this chandelier is guaranteed to turn some heads. Diameter 100cm.



120  
47 1/4"

Ø 100  
39 3/8"



# L'ESTRO ARMONICO

Design by Maestro Vittorio Polesel

## Luxury crystal chandelier.

L'Estro Armonico is one of the most intricate and masterful chandeliers in our collection. This seemingly simple piece is riddled with fascinating details, including tiny crystal pendants which are true masterpieces of Venetian glassblowing. This unique piece is a harmonious and well-proportioned product which we believe to be inimitable. Diameter 100cm.

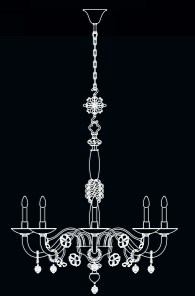

105  
41 3/8"

Ø 100  
39 3/8"





# LAGUNA PLANET

Design by Maria Grazia Rosin

## Surreal, quirky artistic piece.

Laguna Planet is a quirky and playful chandelier conceived for unique spaces. The surreal shapes and colours of this piece make it the perfect accent piece for hospitality or residential projects. This product is highly customisable and interactively fascinating. Diameter 82cm.

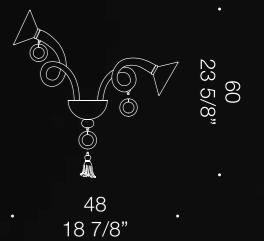

LAGUNA PLANET A2  
2xMAX 46W E14

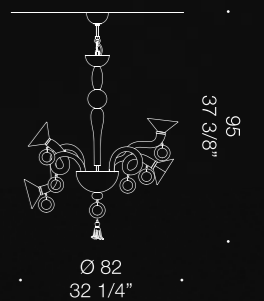

LAGUNA PLANET K8  
8xMAX 46W E14



# Classic design for modern space.

## LANTERNE

Design by Francesco Dei Rossi

These pieces have a seamless and sleek design. Even though the design itself might be considered classical, it really stands out in a modern interior. They feature a light internal metal frame that holds two hand blown glass components together. A perfect product to mix and match, also really useful for contract and hospitality projects. In fact, it comes in 3 different yet coherent designs. Available in custom finishes. Diameter 32cm or 35cm.



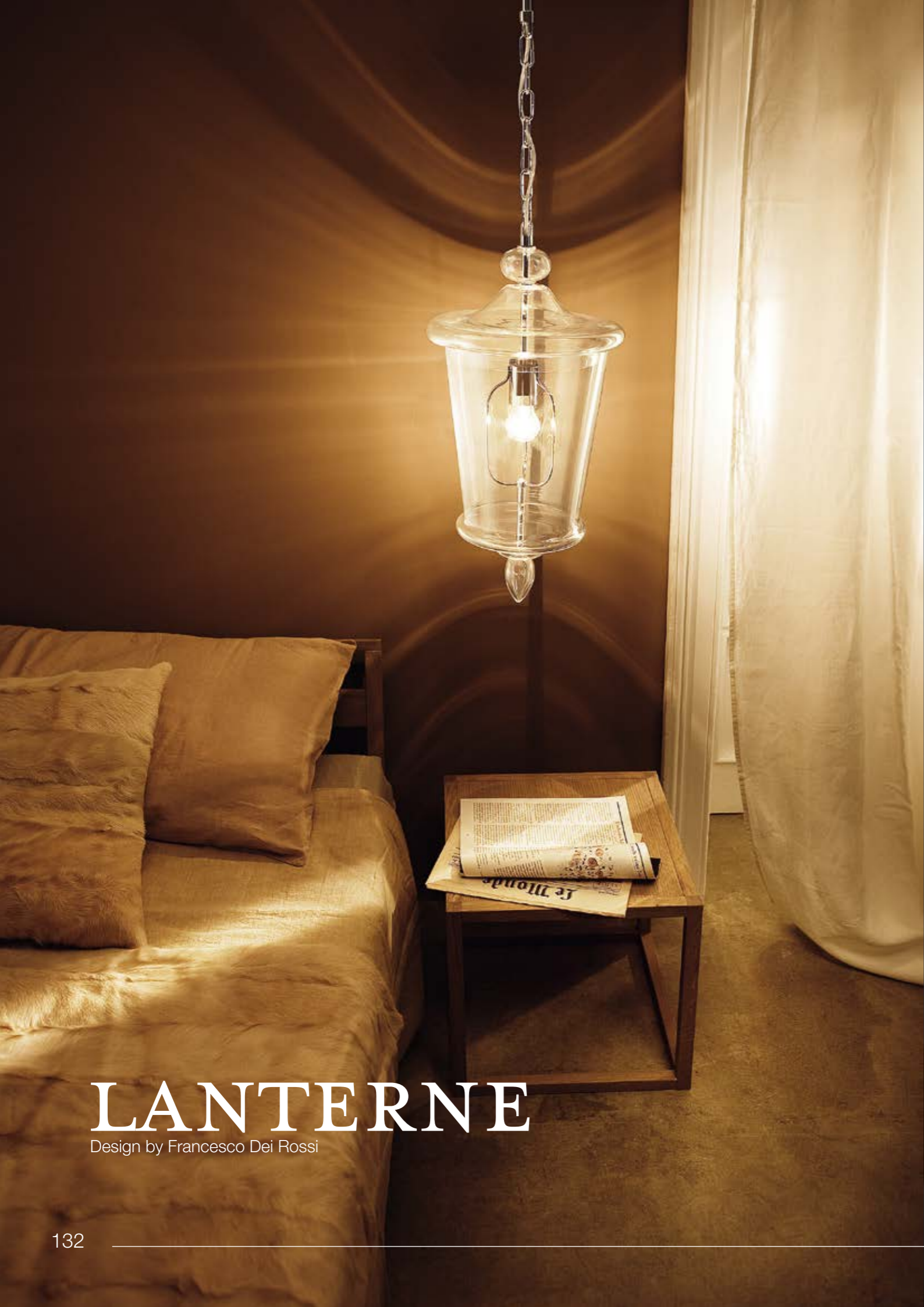

# LANTERNE

Design by Francesco Dei Rossi





# LEVANTE

Design by Francesco Dei Rossi

## Glamorous art piece.

Levante is "the chandelier" by definition. A beautiful and ornate piece which is highly customisable beyond imagination. The grey and darker grey tones of this piece make it a glamorous accent piece for residential or hospitality projects. Featuring the unique option to fit real candles, this piece also gives light from its centrepiece with a LED system which makes Levante shimmer. Dimensions vary.

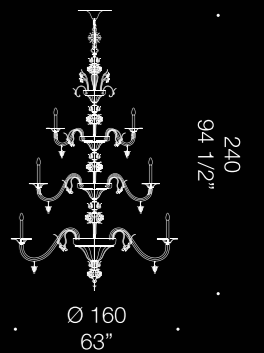

LEVANTE K21+15+9  
45xMAX 46W E14



LEVANTE K15+9  
24xMAX 46W E14



LEVANTE K15  
15xMAX 46W E14

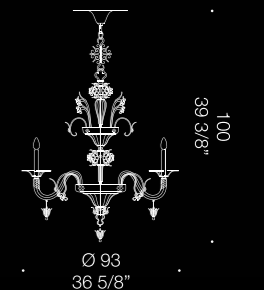

LEVANTE K9  
9xMAX 46W E14



# MADemoiselle

Design by Nicola Grandesso

## High fashion inspired chandelier.

Madmoiselle is a glamorous and stylish chandelier inspired by the icons of high fashion. It is considered a modern looking chandelier which, on the other hand, preserves traditional glassblowing techniques in the making. The contrast between the lampshades and the glossy finish of the arms makes it an original choice for a chic interior. Diameter varies upon configuration, min diameter 70cm, max diameter 100cm. Available in custom finishes and sizes.

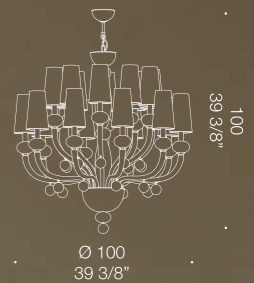

MADemoiselle K20  
20xMAX 46W E14

100  
39 3/8"

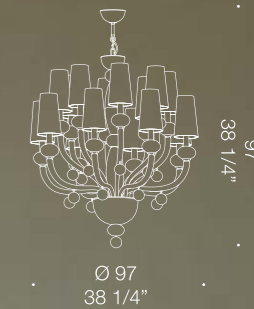

MADemoiselle K16  
16xMAX 46W E14

97  
38 1/4"

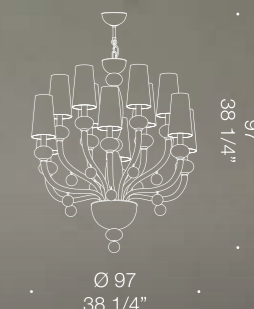

MADemoiselle K12  
12xMAX 46W E14

97  
38 1/4"

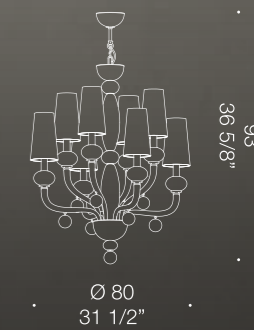

MADemoiselle K8  
8xMAX 46W E14

93  
36 5/8"

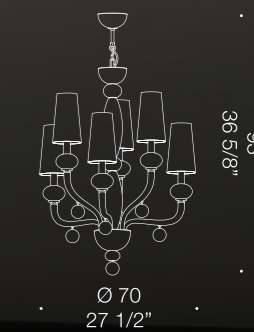

MADemoiselle K6  
6xMAX 46W E14

93  
36 5/8"

Ø 70  
27 1/2"



# MADemoiselle

Design by Nicola Grandesso

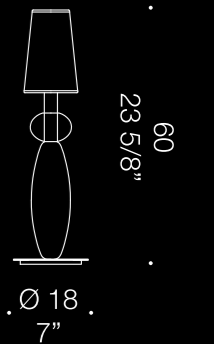

MADemoiselle T  
1xMAX 46W E14

CE  
E2008

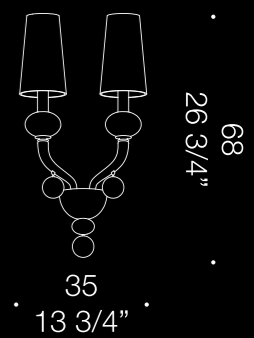

MADemoiselle A2  
2xMAX 46W E14

CE  
E2008



# MADRIGALESCO

Design by Maestro Christian Ballarin

## A true masterpiece.

Madrigalesco is an intricate and ornate chandelier which features an incredibly high number of details. The floral and elegant look makes this the perfect accent piece for a luxurious interior. The high level of craftsmanship and glassblowing makes this piece one of the most remarkable in our collection. Diameter 100cm.









**NATURAL**  
Design by Nicola Grandesso

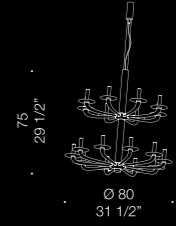
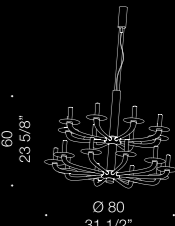
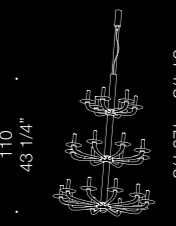
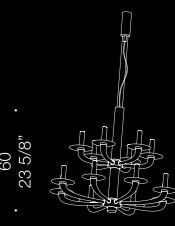
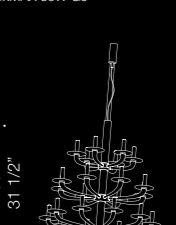
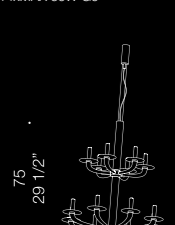

# Minimal luxury design.

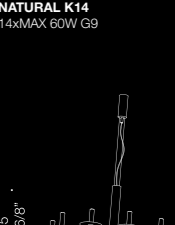
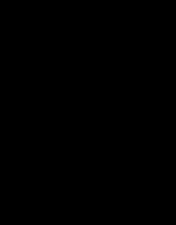
Natural's aesthetic is unique and modern. It's minimal look stands out for the clean lines and elegant nuance. Available in several different configurations, this piece is ideal for minimalist projects and modern homes. Handmade in Murano. Dimensions vary.

 <p>75 29 1/2"</p> <p>36 3/8" - 114 1/8"</p> <p>Ø 80 31 1/2"</p> <p><b>NATURAL K18</b> 18xMAX 60W G9</p>	 <p>60 23 5/8"</p> <p>30" - 108 5/8"</p> <p>Ø 80 31 1/2"</p> <p><b>NATURAL KP18</b> 18xMAX 60W G9</p>
 <p>110 43 1/4"</p> <p>130 - 330 51 1/8" - 129 7/8"</p> <p>Ø 80 31 1/2"</p> <p><b>NATURAL K24</b> 24xMAX 60W G9</p>	 <p>60 23 5/8"</p> <p>30" - 108 5/8"</p> <p>Ø 70 27 1/2"</p> <p><b>NATURAL KP14</b> 14xMAX 60W G9</p>
 <p>80 31 1/2"</p> <p>96 - 296 37 3/4" - 116 1/2"</p> <p>Ø 80 31 1/2"</p> <p><b>NATURAL K24</b> 24xMAX 60W G9</p>	 <p>75 29 1/2"</p> <p>90 - 290 36 3/8" - 114 1/8"</p> <p>Ø 70 27 1/2"</p> <p><b>NATURAL K14</b> 14xMAX 60W G9</p>
 <p>45 17 6/8"</p> <p>60 - 260 23 5/8" - 102 9/8"</p> <p>Ø 80 31 1/2"</p> <p><b>NATURAL KP24</b> 24xMAX 60W G9</p>	 <p>45 17 6/8"</p> <p>60 - 260 23 5/8" - 102 9/8"</p> <p>Ø 70 27 1/2"</p> <p><b>NATURAL K10</b> 10xMAX 60W G9</p>
 <p>45 17 6/8"</p> <p>60 - 260 23 5/8" - 102 9/8"</p> <p>Ø 50 19 5/8"</p> <p><b>NATURAL K8</b> 8xMAX 60W G9</p>	 <p>45 17 6/8"</p> <p>60 - 260 23 5/8" - 102 9/8"</p> <p>Ø 50 19 5/8"</p> <p><b>NATURAL K6</b> 6xMAX 60W G9</p>





# NOOR PENDANT

Design by Francesco Dei Rossi

## A visionary tale of cultural fusion.

Keeping alive traditional Murano glassmaking heritage while aesthetically drifting towards exotic nuances, Noor represents a well balanced conglomerate of different styles which resolves into the craft of unique lighting pieces which boast a strong character - made by masterful artisans in Murano.

A visionary tale which translates in a collection of opulent lamps and chandeliers, sought after for its effortlessly elegant and sophisticated look. The intertwining of metal patterns with artisanal glass communicates authentic luxury, never sacrificing the importance of light itself, which is the true protagonist of this collection. Each texture is strongly enhanced by the use of light, which almost magically travels along each shape and really carries out a glamorous contrast between materials. Each piece is given the option to be customised as far as metal coatings/treatments and glass colours - this allows further material experimentation and the creation of bespoke and sophisticated pieces.

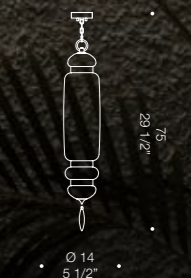

NOOR S2  
1xMAX 46W E14



NOOR S1  
1xMAX 46W E14

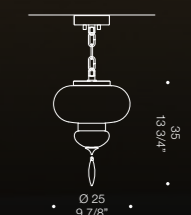

NOOR S  
3xMAX 33W G9



# NOOR OUTDOOR SCONCE

Design by Francesco Dei Rossi

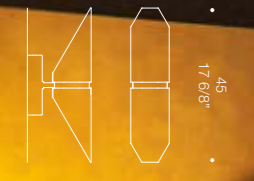

NOOR A LED Outdoor  
Included led 2700K CRI 90  
6W 600 lm

CE  
RoHS



# NOOR LANTERN

Design by Francesco Dei Rossi

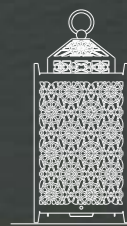

56

22"

20

7 7/8"

**NOOR T**  
1xMAX 77W E27 or  
Candle diameter 10 cm



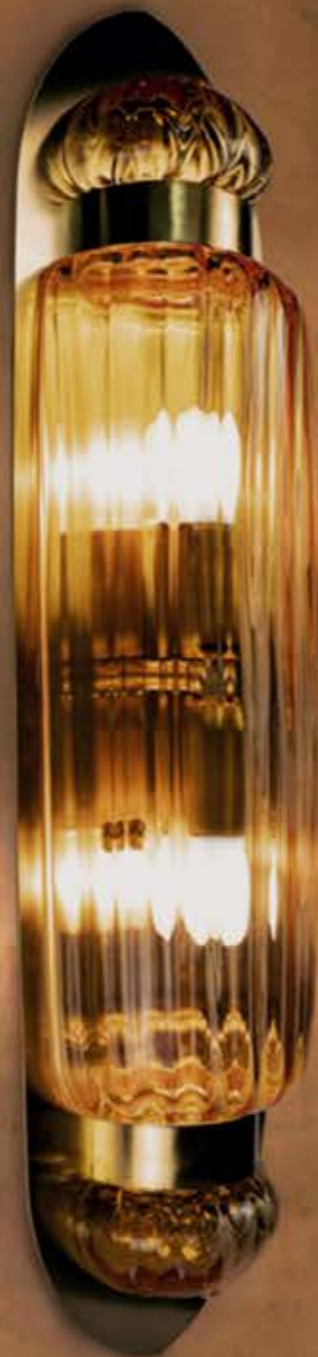

# NOOR INDOOR SCONCE

Design by Francesco Dei Rossi

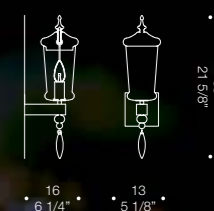

NOOR A  
1xMAX 46W E14



NOOR A  
2xMAX 46W E14



# NOOR CEILING LAMP

Design by Francesco Dei Rossi



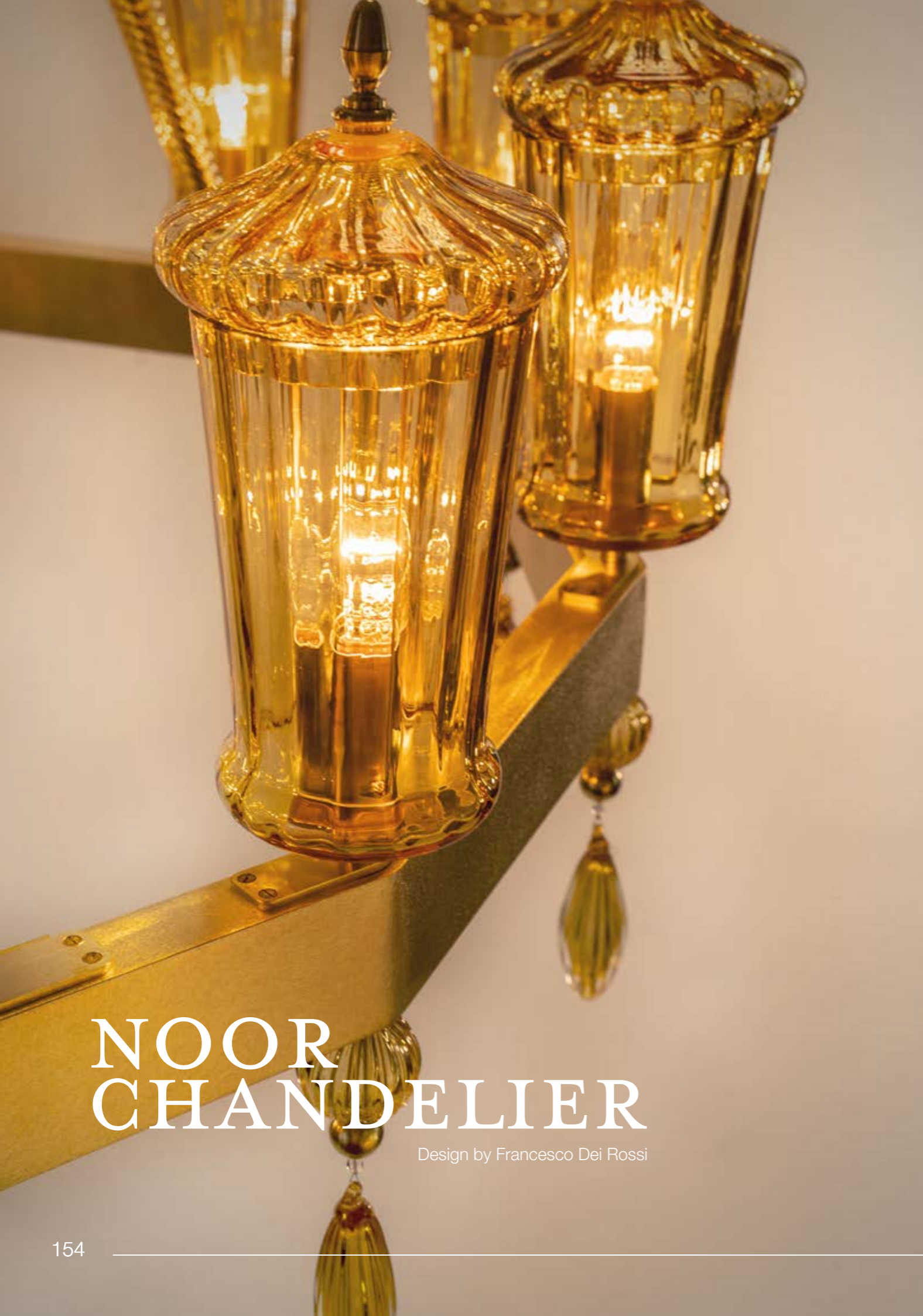

# NOOR CHANDELIER

Design by Francesco Dei Rossi

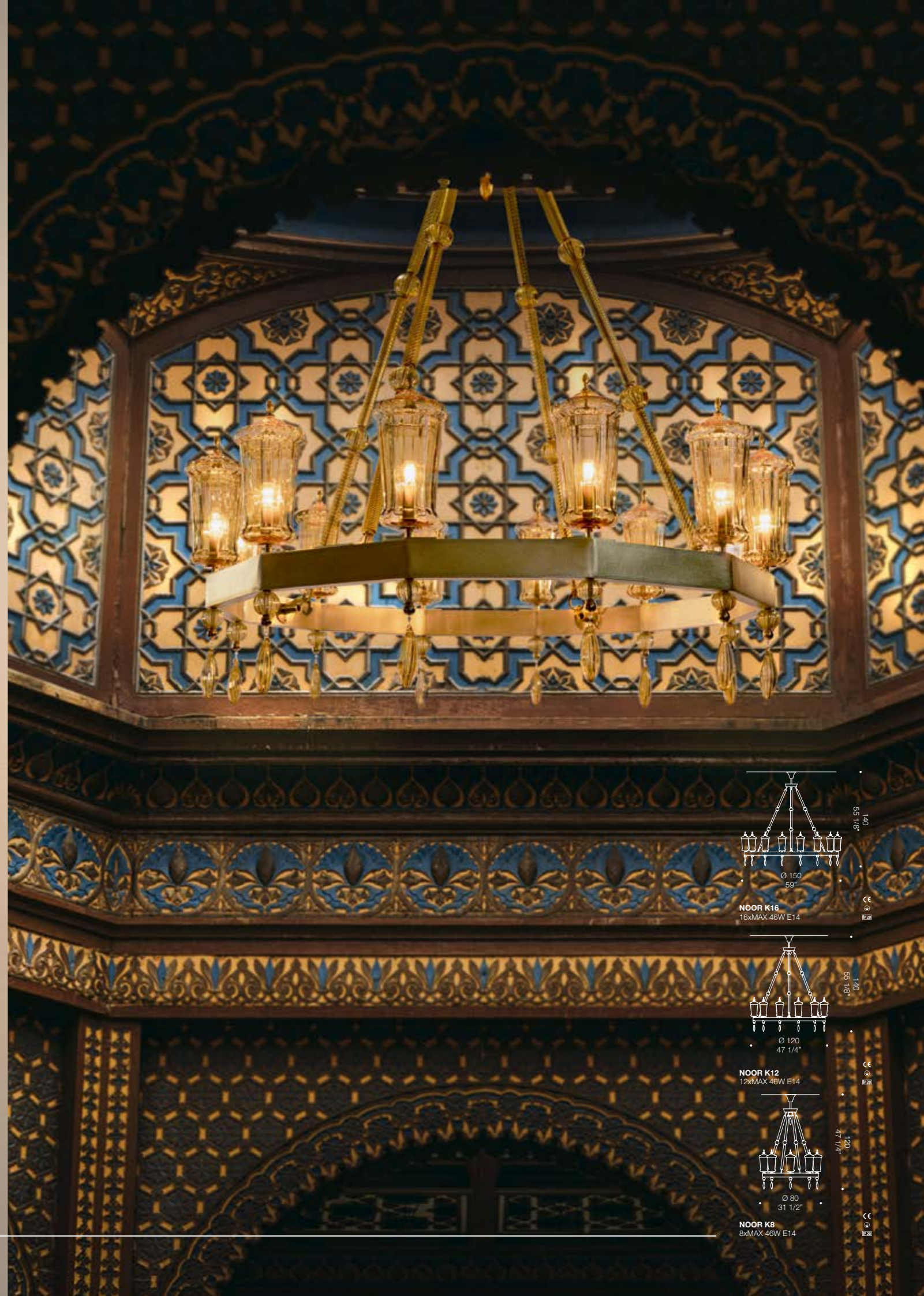

NOOR K16  
16xMAX 46W E14



NOOR K12  
12xMAX 46W E14



NOOR K8  
8xMAX 46W E14



# PORTOFINO

Design by de Maio Heritage

## Venetian luxury heritage.

Portofino is a ceiling and wall lamp which represents a long heritage of Venetian elegance and luxury. The internal metal frame is concealed by beautifully crafted leaves. This timeless lighting piece is highly customisable according to the client's needs. Available in custom finishes, configurations and sizes.



PORTOFINO A0  
2xMAX 46W E14



PORTOFINO A1  
5xMAX 46W E14

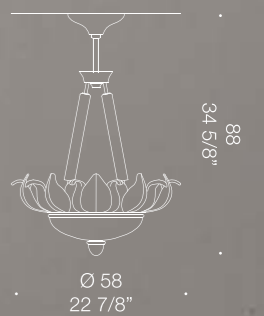

PORTOFINO S0  
9xMAX 46W E14

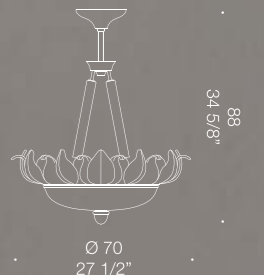

PORTOFINO S1  
12xMAX 46W E14

€  
€  
€  
€



# PORTOFINO

Design by de Majo Heritage

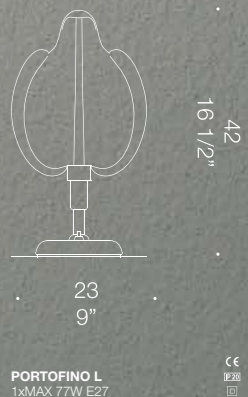





# PORTOFINO

Design by de Majo Heritage



PORTOFINO P0  
9xMAX 46W E14



PORTOFINO P1  
12xMAX 46W E14



PORTOFINO P2  
8xMAX 46W E14



# QUATTRO STAGIONI

Design by Francesco Dei Rossi - Roberto Assenza



## An unbelievable grand masterpiece.

Often referred to as a masterpiece, this huge chandelier represents the passing of each of the four seasons. Meant to shine the grand hall of a luxurious hospitality space, this piece does not go unnoticed, perhaps for its unique features and highly ornate surface. The amount of work which goes into Quattro Stagioni is simply unmatched. This piece really speaks for itself. Height 300cm, diameter 150cm.



Ø 300  
118 7/8"

Ø 150  
59"

QUATTRO STAGIONI  
72xMAX 20W G4 12V





# RAPALLO

Design by de Majo Heritage

## Venetian style heritage lamp.

Rapallo is a classic Venetian style ceiling and wall lamp. Highly customisable and available in many different configurations, there's really no limit to use cases. This product is highly competitive for contract projects and a highly sought-after piece for designers. Dimensions vary.



RAPALLO A2  
2xMAX 46W E14



RAPALLO A3  
3xMAX 46W E14



RAPALLO A12  
12xMAX 46W E14



# RAPALLO

Design by de Majo Heritage



Ø 100  
39 3/8"

**RAPALLO S14**  
14xMAX 46W E14



Ø 100  
39 3/8"

**RAPALLO P10**  
10xMAX 46W E14



Ø 150  
59"

**RAPALLO P20**  
20xMAX 46W E14



# ROSETO

Design by Francesco Dei Rossi



## A rose garden for your interior.

Roseto is a beautiful and elaborate chandelier inspired by the aesthetics of a rose garden. The rich details and colours make this piece an eye-catcher. Made with traditional glassblowing techniques, the glossy flowers make a glorious contrast with the grey glass components and the 24K gold leaf details. A charming piece which communicates timeless elegance and opulence. Diameter 90cm. Available in custom finishes and sizes.



ROSETO A2  
2xMAX 46W E14



ROSETO A3  
3xMAX 46W E14

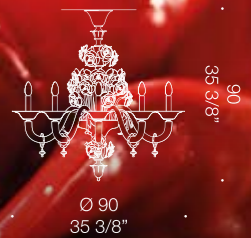

ROSETO K10  
10xMAX 46W E14



ROSETO K10  
10xMAX 46W E14  
With 30 cm chain + canopy



**SARA**  
Design by Roberto Assenza



# High-class detailed piece.

Sara is an elegant chandelier which comes in several different sizes and configurations. The design of this product is detail rich yet well balanced and perfectly proportioned. It communicates a sense of grandeur, without renouncing its sobriety and class. Handmade in Murano, Sara is a great option for any high-end interior.

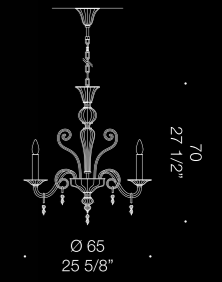

**SARA K6**  
6xMAX 46W E14

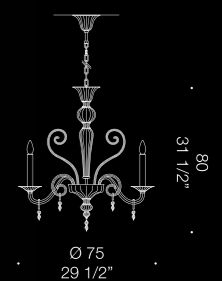

**SARA K8**  
8xMAX 46W E14

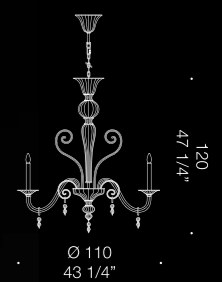

**SARA K10**  
10xMAX 46W E14



**SARA K12**  
12xMAX 46W E14

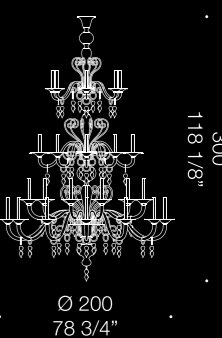

**SARA K42**  
42xMAX 46W E14



# SARA

Design by Roberto Assenza



SARA A2  
2xMAX 46W E14



SARA A3  
3xMAX 46W E14





# TERRA

Design by Roberto Assenza - Francesco Dei Rossi



## Earth inspired chandelier.

Terra is an uniquely designed chandelier which represents The Earth. The design of this piece can be described as "sprouting". This product represents the thriving force of nature which is uncontainable and everlasting. Diameter 100cm.



90  
35 3/8"

Ø 100  
39 3/8"

TERRA K8  
8xMAX 46W E14

CE  
E28

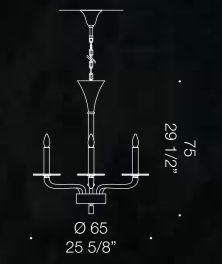

**TETRA K6**  
8xMAX 46W E14

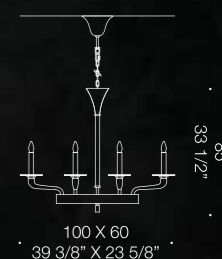

**TETRA K8L**  
8xMAX 46W E14

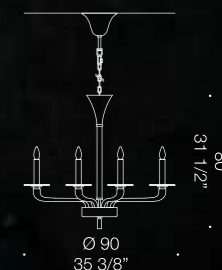

**TETRA K8**  
8xMAX 46W E14

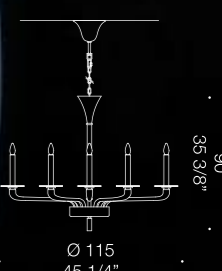

**TETRA K12**  
12xMAX 46W E14

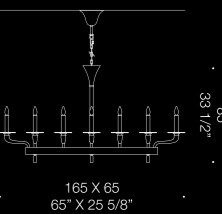

**TETRA K16**  
16xMAX 46W E14

# Moody, elegant piece.

Tetra is a very elegant and sleek product which defies the traditional rounded nature of a chandelier. This design is highly influenced by the figure of a square. Perfect for a variety of interiors, this accent piece is highly customisable. Available in different configurations, including a rectangular version, suggested to hang over a dinner table.

**TETRA**  
Design by Francesco Dei Rossi - Roberto Assenza



# TETRA

Design by Francesco Dei Rossi - Roberto Assenza

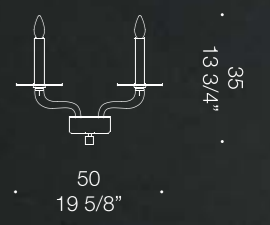

**TETRA A2**  
2xMAX 46W E14

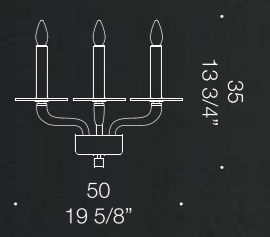

**TETRA A3**  
3xMAX 46W E14



# VENEDIG POM PON

Design by Maria Grazia Rosin

## Pop art inspired lamp.

This whimsical chandelier is hugely inspired by pop art. The quirky look conceals rich handmade details which stand out in a playful interior. This piece is far more similar to a sculptural piece than a lighting piece. Also available as wall lamp. Diameter 88cm.



VENEDIG POM PON A2  
2xMAX 46W E14

CE

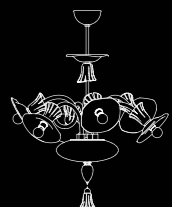

Ø 88  
34 5/8"

VENEDIG POM PON K6  
6xMAX 46W E14

CE



# VENEGIANO

Design by Maria Grazia Rosin



## Playful, luxurious accent piece.

Venegiano is an unique, quirky but elegant chandelier which features very interesting handmade details. A double class "cup" component contributes to the very organic and dynamic look. Coloured stripes and twirly details almost make this chandelier look like its made out of jelly. A masterful creation which becomes an accent piece for a variety of interiors. Also available as wall lamp. Diameter 90cm.



VENEGIANO A2  
2xMAX 46W E14



VENEGIANO K6  
6xMAX 46W E14



# VENUSSIANO

Design by Maria Grazia Rosin

50's inspired  
funky piece.

Venussiano chandelier is heavily inspired by the 50's. The stock version of this chandelier comes in a glossy red colour, looking like it stole its look from your favourite soda. The otherworldly look also slightly refers to a space-age look inspired by flying saucers and extraplanetary components. Flat "cup" components sprout in every direction, making this piece also functionally efficient as a lighting device. Diameter 100cm.

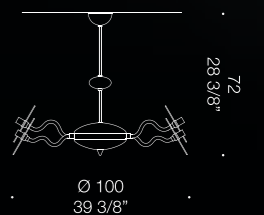

VENUSSIANO K8  
8xMAX 46W E14



# VIVACE

Design by Francesco Dei Rossi - Lucio de Majo

## A new concept of chandeliers.

Highly modular, hi-tech, elegant and precious, Vivace is indeed inspired by motion. Resembling the moves of a director of orchestra, this linear chandelier is a harmonious and dynamic piece which can be tailor made to fit virtually any interior. Its unique system allows this piece to stand out as a modern-style chandelier while preserving original glassblowing techniques. A must-have for a stylish home. Dimensions and configurations vary upon request.

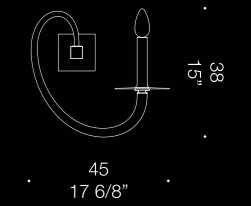

VIVACE A1  
1xMAX 46W E14

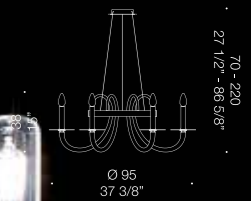

VIVACE K6  
6xMAX 46W E14

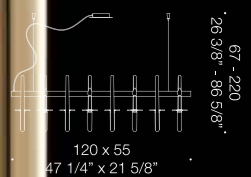

VIVACE K8  
8xMAX 46W E14

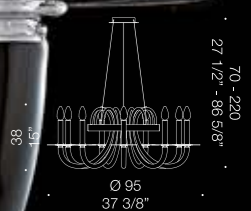

VIVACE K9  
9xMAX 46W E14

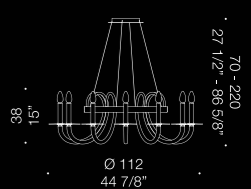

VIVACE K12  
12xMAX 46W E14

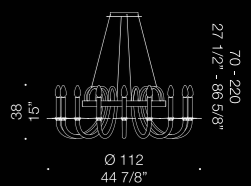

VIVACE K16  
16xMAX 46W E14



# Ode to Venetian glassmaking.

Vivaldi is a “rezzonico” style chandelier which embodies the idea of a perfectly balanced chandelier. A timeless design which doesn't necessarily need to be surrounded by a classic interior. This beautiful and fully customisable chandelier is an ode to Venetian glassmaking, packing a lot of style and craft, and being one of the most sought after chandeliers in our collection. Dimensions and configurations vary upon request. Min diameter 90cm, max diameter 300cm.

# VIVALDI

Design by Francesco Dei Rossi



**VIVALDI A3**  
3xMAX 46W E14 +  
1xMAX 20W G9

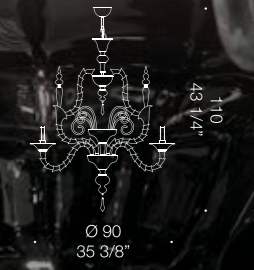

**VIVALDI K6**  
6xMAX 46W E14 +  
3xMAX 20W G9

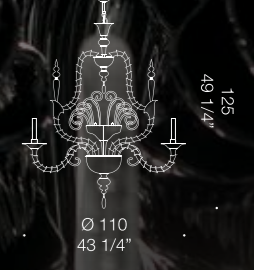

**VIVALDI K9**  
9xMAX 46W E14 +  
6xMAX 20W G9

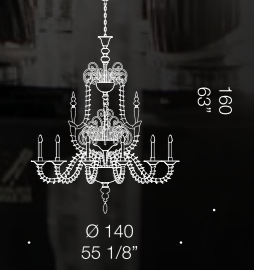

**VIVALDI K12**  
12xMAX 46W E14 +  
12xMAX 20W G9





**2400**  
Design by de Majo Heritage

# Simple, never boring classic.

A simple, highly customizable, sleek chandelier which is perfect for contract projects. Handmade by skilful glassworkers, 2400 has been a best seller in our collection for decades. The amount of configurations for this piece is truly astounding, making it the perfect pick for designers. Available with silk lampshades or highly ornate glass details. Dimensions and configurations vary.

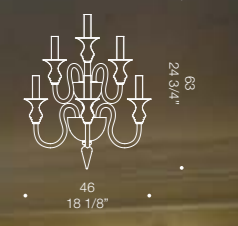

2400 A6  
6xMAX 46W E14

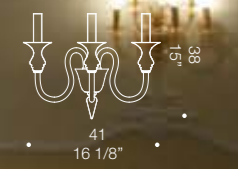

2400 A3  
3xMAX 46W E14

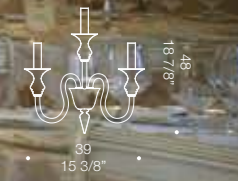

2400 A2+1  
3xMAX 46W E14



2400 A2  
2xMAX 46W E14









2400 A1  
1xMAX 46W E14

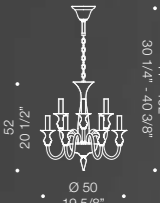
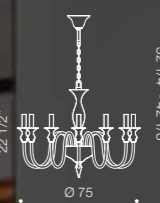
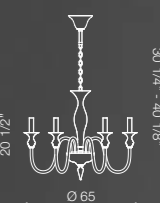
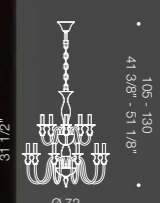
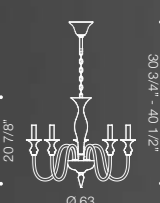

# 2400

Design by de Majo Heritage

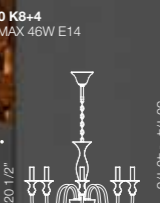
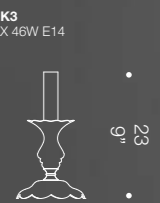
 <p>110 - 135 43 1/4" - 53 1/8" 85 33 1/2" Ø 96 37 3/4"</p> <p><b>2400 K12+6</b> 18xMAX 46W E14</p>	 <p>77 - 102 30 1/4" - 40 3/8" 52 20 1/2" Ø 50 19 5/8"</p> <p><b>2400 K6+3</b> 9xMAX 46W E14</p>
 <p>82 - 107 32 1/4" - 42 1/8" 57 22 1/2" Ø 75 29 1/2"</p> <p><b>2400 K12</b> 12xMAX 46W E14</p>	 <p>77 - 102 30 1/4" - 40 1/8" 52 20 1/2" Ø 65 25 5/8"</p> <p><b>2400 K6</b> 6xMAX 46W E14</p>
 <p>105 - 130 41 3/8" - 51 1/8" 80 31 1/2" Ø 72 28 3/8"</p> <p><b>2400 K10+5</b> 15xMAX 46W E14</p>	 <p>78 - 103 30 3/4" - 40 1/2" 53 20 7/8" Ø 63 24 3/4"</p> <p><b>2400 K5</b> 5xMAX 46W E14</p>
 <p>146 - 171 57 1/2" - 67 3/8" 121 47 5/8" Ø 134 52 7/8"</p> <p><b>2400 K24+12+6</b> 42xMAX 46W E14</p>	 <p>77 - 102 30 1/4" - 40 1/8" 52 20 1/2" Ø 72 28 3/8"</p> <p><b>2400 K10</b> 10xMAX 46W E14</p>
 <p>117 - 142 46" - 56" 92 36 1/4" Ø 134 52 7/8"</p> <p><b>2400 K24+12</b> 36xMAX 46W E14</p>	 <p>105 - 130 41 3/8" - 51 1/8" 80 31 1/2" Ø 72 28 3/8"</p> <p><b>2400 K3+4</b> 12xMAX 46W E14</p>
 <p>110 - 135 43 1/4" - 53 1/8" 85 33 1/2" Ø 96 37 3/4"</p> <p><b>2400 K16+8</b> 24xMAX 46W E14</p>	 <p>77 - 102 30 1/4" - 40 1/8" 52 20 1/2" Ø 72 28 3/8"</p> <p><b>2400 K8</b> 8xMAX 46W E14</p>
	 <p>23 9" Ø 11 4 3/8"</p> <p><b>2400 L</b> 1xMAX 46W E14</p>



# Authentic Venetian heritage.

## 2599

Design by de Majo Heritage

Slightly less ornate than 2400, 2599 is a simple and stylish chandelier which comes in a vast number of configurations. A piece which is loved by designers for its custom nature. A great piece for budget projects which still require a lot of style. Dimensions and configurations vary.

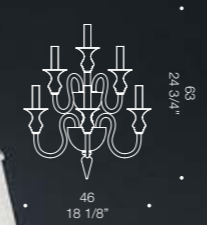

**2599 A6**  
6xMAX 46W E14

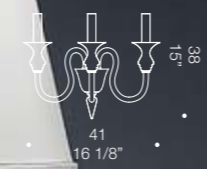

**2599 A3**  
3xMAX 46W E14

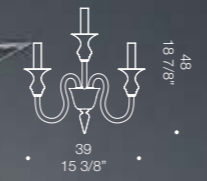

**2599 A2+1**  
3xMAX 46W E14



**2599 A2**  
2xMAX 46W E14

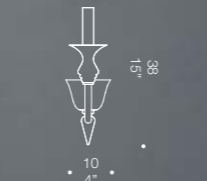

**2599 A1**  
1xMAX 46W E14

# 2599

Design by de Majo Heritage



**2599 K16+8**  
24xMAX 46W E14

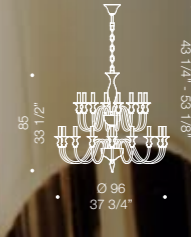

**2599 K12+6**  
18xMAX 46W E14



**2599 K10**  
10xMAX 46W E14

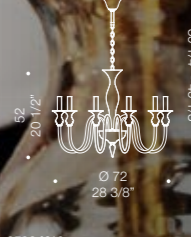

**2599 K8**  
8xMAX 46W E14

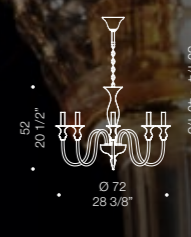

**2599 K24+12+6**  
42xMAX 46W E14

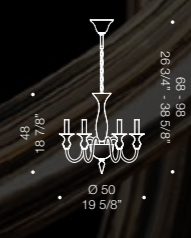

**2599 K6**  
6xMAX 46W E14

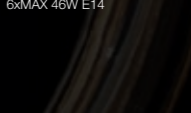

**2599 K5**  
5xMAX 46W E14



**2599 KP5**  
5xMAX 46W E14



**2599 KP3**  
3xMAX 46W E14

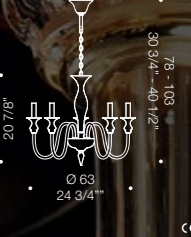

**2599 KP6**  
6xMAX 46W E14

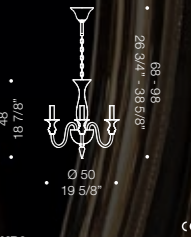

**2599 K3**  
3xMAX 46W E14



**2599 L**  
1xMAX 46W E14



# 2612

Design by de Majo Heritage

## Nostalgic Venetian feel.

An elegant, traditional and simple piece which decorates many homes in the Venetian territory. The nostalgic design of this chandelier is a relievant testimony of authentic Venetian culture and style. Available in several different configurations, this piece is highly sought after due to its unique aesthetic and effortless elegance. Dimensions and configurations vary.



2612 K6  
6xMAX 46W E14

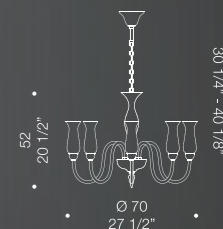

2612 K8  
8xMAX 46W E14



2612 K10  
10xMAX 46W E14

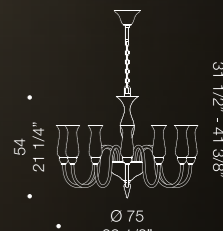

2612 K12  
12xMAX 46W E14

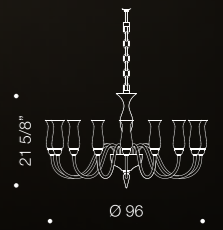

2612 K16  
16xMAX 46W E14



# 2612

Design by de Majo Heritage



2612 A1  
1xMAX 46W E14

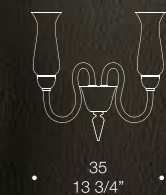

2612 A2  
2xMAX 46W E14

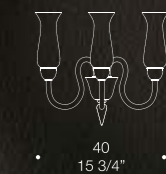

2612 A3  
3xMAX 46W E14

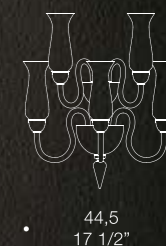

2612 A3+2  
5xMAX 46W E14





# 6012

Design by Francesco De Rossi

## Charming, elegant piece.

6012 is a handblown chandelier which was designed in order to be perfect for simple elegant interiors and contract. The number of ribbed clear glass components create a fascinating refraction effect, making this a non-invasive piece for a bright interior. Diameter 95cm, 115cm or 130cm.



6012 K8  
8xMAX 46W E14



6012 K10  
10xMAX 46W E14

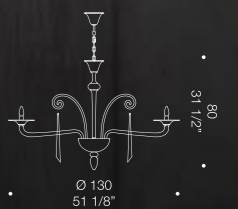

6012 K12  
12xMAX 46W E14



# 6013

Design by Francesco De Rossi

## Majestic, compact, sleek.

6013 is a chandelier composed of “rigadin ritorto” patterns all over. The way light travels across the volume of this product makes it a great choice for a bright interior. This piece was designed in order to fit in rooms with a lower ceiling, and due to its slightly reduced height, it has been a best seller in smaller houses and apartments, as well as hospitality bedrooms. Comes in different configurations, diameter 110cm, 120cm or 135cm. Height 62cm or 70cm.



6013 K10  
10xMAX 40W E14



6013 K12  
12xMAX 40W E14

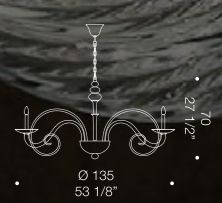

6013 K16  
16xMAX 40W E14





# Aesthetically perfect.

# 6014

Design by Francesco De Rossi

6014 is a beautifully handblown chandelier with a captivating aesthetic. The soft curves which compose this product are proportioned and carefully put together. The result is an elegant, chic piece which features 24K gold leaf submerged in clear glass. Colour and finish are customizable, as well as size and configurations. Diameter 120cm.

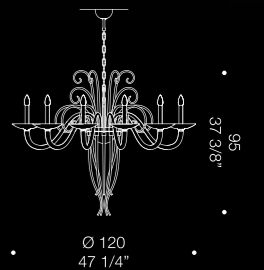

6014 K12  
12xMAX 46W E14 +  
4xMAX 20W G9

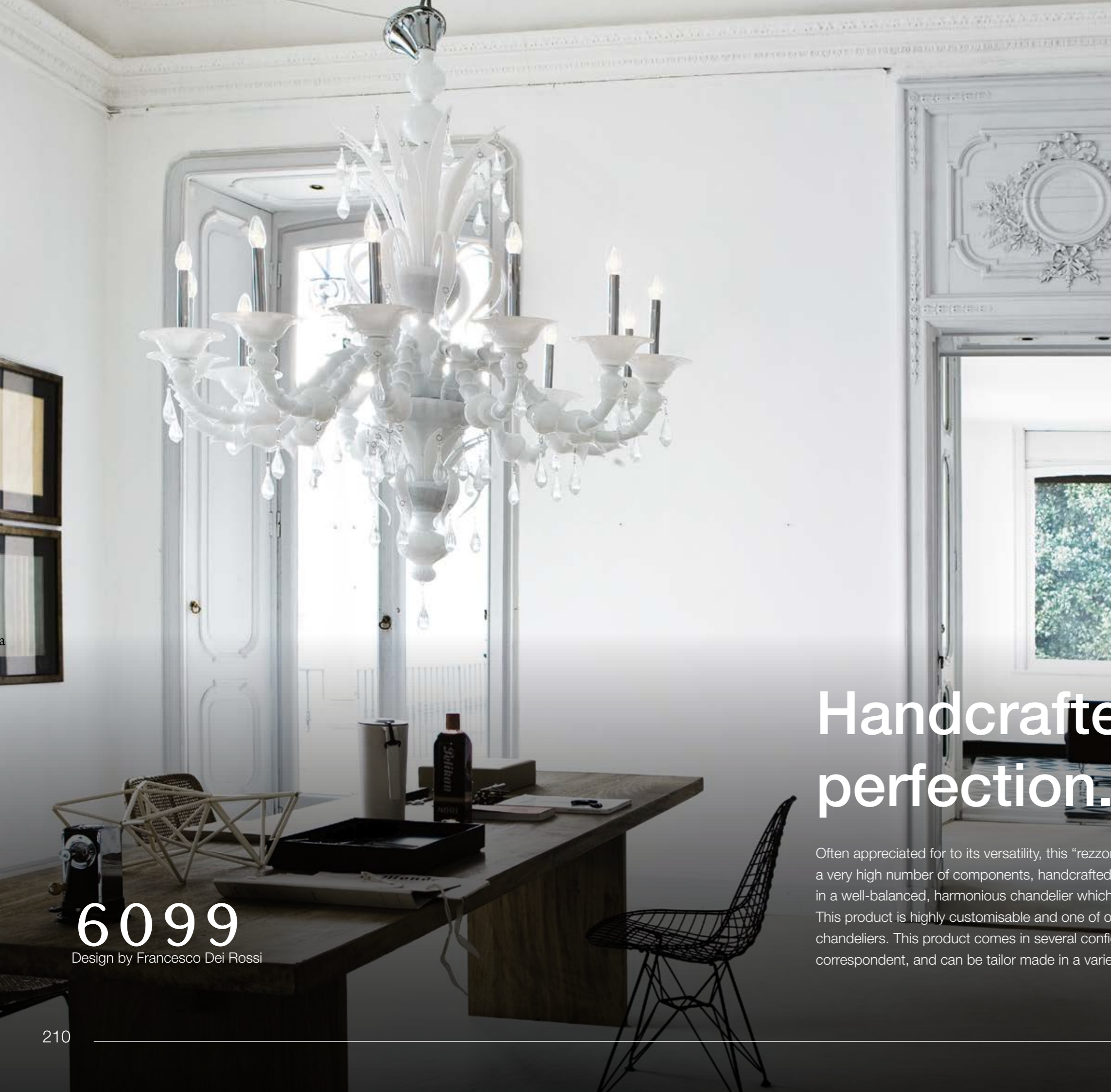

# Handcrafted to perfection.

Often appreciated for its versatility, this “rezzonico” style chandelier features a very high number of components, handcrafted to perfection in order to result in a well-balanced, harmonious chandelier which is guaranteed to turn heads. This product is highly customisable and one of our best selling traditional chandeliers. This product comes in several configurations, including a wall lamp correspondent, and can be tailor made in a variety of sizes and colours.

# 6099

Design by Francesco Dei Rossi



6099 A3  
3xMAX 46W E14



6099 K8  
8xMAX 46W E14



6099 K10  
10xMAX 46W E14

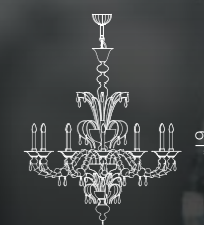

6099 K12  
12xMAX 46W E14



6099  
Design by Francesco Dei Rossi





# 7055

Design by de Majo Heritage

## Unique glass working techniques.

7055 is a classical looking chandelier with coloured accents and stunning handcrafted details. Featuring uncommon and rather unique glass working techniques, some of the details on this piece are a really fascinating insight on the attention to detail which is put into artisanal glassmaking. Includes 24K gold leaf applications and is highly customisable. Configurations also include a wall lamp version and a table lamp version. Dimensions vary.



7055 L  
1xMAX 46W E14



7055 A2  
2xMAX 46W E14



7055 A3  
3xMAX 46W E14



7055 K6  
6xMAX 46W E14



7055 K8  
8xMAX 46W E14



7055 K10  
10xMAX 46W E14



# Stunning handcrafted details.

7056 is a classical looking chandelier with coloured accents and stunning handcrafted details. Unlike its counterpart (7055), this beautiful and uniquely ornate piece features arms which point downwards. This design choice accommodates many clients' or designers' need to shine more light in a specific interior area. Highly customisable, this product comes in a variety of configurations including wall lamp, table lamp and floor lamp.

# 7056

Design by de Majo Heritage



7056 K6  
6xMAX 46W E14



7056 K8  
8xMAX 46W E14

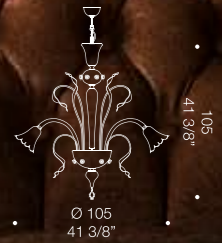

7056 K10  
10xMAX 46W E14



7056 K12  
12xMAX 46W E14



# 7056

Design by de Majo Heritage

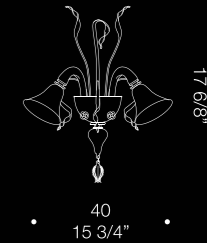

7056 A2  
2xMAX 46W E14

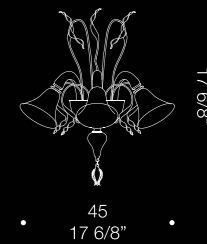

7056 A3  
3xMAX 46W E14



7056 L  
1xMAX 46W E14



7056 R6  
6xMAX 46W E14



# 7060

Design by de Majo Heritage

## True Venetian masterpiece.

7060 is a true Venetian masterpiece come to life. This “rezzonico” style chandelier features a number of unique features, including ming blowing details and the possibility to customise coloured accents. Often compared to a garden, the number of floral elements is harmoniously put together in a well proportioned composition. This kind of product is an exclusive heirloom which survives the test of time and gains historical value, as very few are able to execute a lighting piece this precious. Available in several configurations, including wall lamp. Diameter 80cm, 100cm or 110cm.





# Timeless grand chandelier.

7061 represents a celebration of Venetian artisanal glassblowing. This “rezzonico” style chandelier features a very high number of handmade components which are harmoniously put together in a mind blowing, beautifully balanced composition. Some of the details present in this product are hidden gems. 7061 is virtually impossible to replicate, as only the most masterful glassblowers can attempt this piece. Perfect for clients looking for grandeur, this piece is a display of authentic Venetian heritage in its true form - a heirloom piece which gains value over time due to its uniqueness. Highly customizable. Diameter 120cm or 140cm.

# 7061

Design by de Majo Heritage



145  
57 7/8"

Ø 120  
47 1/4"

7061 K6+3  
9xMAX 46W E14

CE  
E28



165  
65"

Ø 140  
55 1/8"

7061 K8+4  
12xMAX 46W E14

CE  
E28



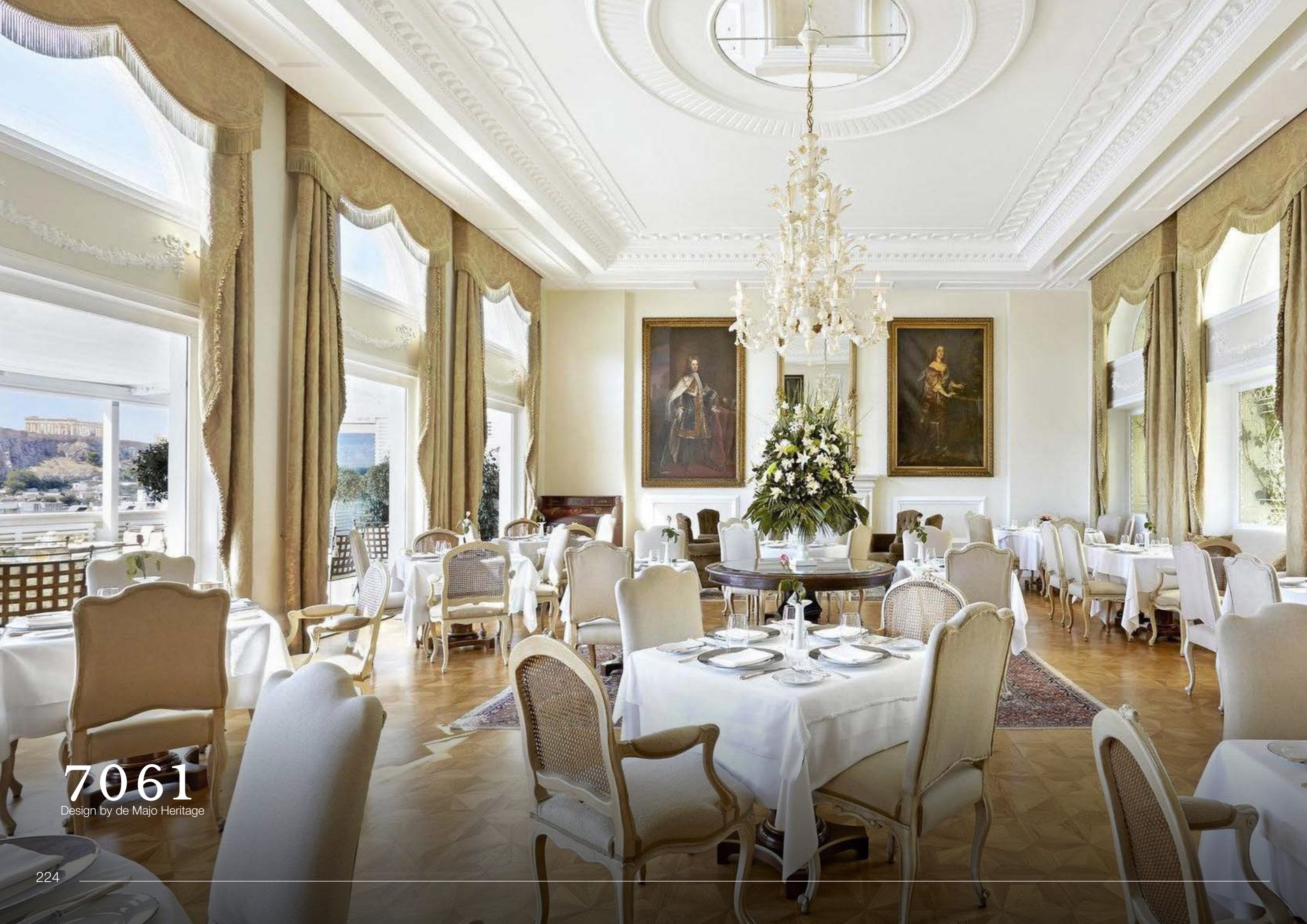

7061  
Design by de Majo Heritage



# 7063

Design by de Majo Heritage

## Timelessly elegant traditional piece.

7063 is a masterpiece of Venetian artisanal glassblowing. This composition is a highly ornate engineering wonder. A “rezzonico” style chandelier which develops in three levels and looks structurally unique. Beautifully handcrafted details confer great wealth to the look of this piece, while maintaining strict elegance, as for Venetian tradition. 7063 comes in several configurations, including wall lamp, and is highly customizable. Diameter 90cm, 110cm, 120cm.

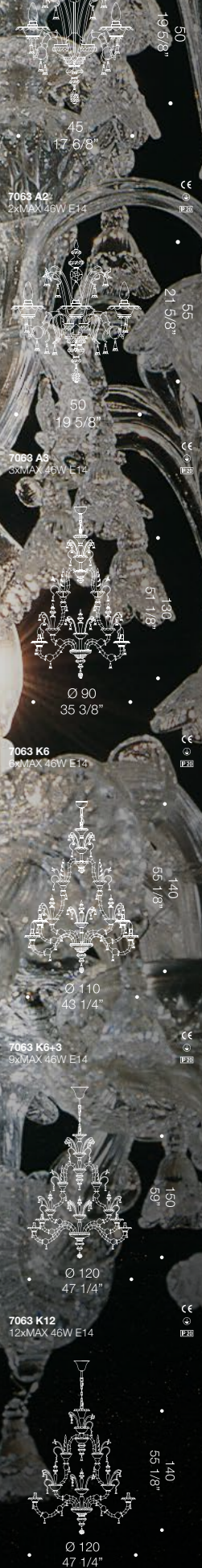

# 7065

Design by de Majo Heritage

## True-to-itself Venetian chandelier.

7065 is perhaps the most true-to-itself Venetian chandelier. A strong heritage is passed onto this piece, which, in a nutshell, features a number of traditional Venetian glass working techniques. Highly ornate pastorals and multicoloured floral elements represent a celebration of traditional glassware, while maintaining a sophisticated look. The number of customisable details on this piece is hard to describe, and has to be seen to be understood. A surprisingly compact accent piece for a luxurious and timeless interior. Several configurations available, including a wall lamp version. Diameter 70cm, 75cm, 80cm or 90cm.





7065

Design by de Majo Heritage





# 7067

Design by de Majo Heritage

## A precious heritage piece.

7067 is a beautiful traditional style chandelier which is popular thanks to its beautiful colour tones, which contribute to a sophisticated yet bold look. This piece is a Venetian classic, and comes in different configurations, including a wall lamp version. The level of detailing in this piece is amongst the highest in our collection, placing this product in a niche category of authentic Venetian wonders. Diameter 80cm, 90cm and 110cm.



7067 A2  
2xMAX 46W E14



7067 A3  
3xMAX 46W E14

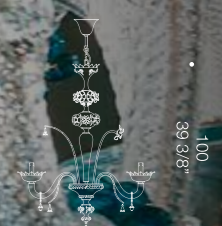

7067 K6  
6xMAX 46W E14



7067 K8  
8xMAX 46W E14



7067 K10  
10xMAX 46W E14



# 7074

Design by de Majo Heritage

## Rich 24K gold texture.

7074 is a traditional style chandelier with an extremely rich look, due to its double 24K gold leaf application on all handmade components. Each piece is put together proportionally and features unique coloured glass decorations. A beautiful piece for a classic interior, highly customisable and available in several configurations including a wall lamp version. Diameter 70cm, 80cm, 100cm and 120cm.





# 7077

Design by de Majo Heritage



## Simply elegant, never ordinary.

7077 is a simple and timeless traditional style chandelier which is handmade in Murano. Among the traditional foliage decor, you'll notice a coloured edge, available in a great variety of palettes. This piece was carefully designed in order to fit a minimal interior environment, while being a typical Venetian piece. Highly customizable and available in several different configurations, including a wall lamp version. Diameter 70cm, 80cm, 95cm and 110cm.

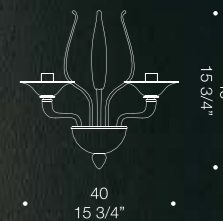

7077 A2  
2xMAX 46W E14

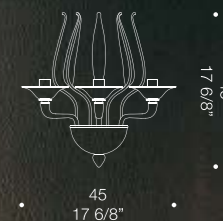

7077 A3  
3xMAX 46W E14



7077 K6  
6xMAX 46W E14

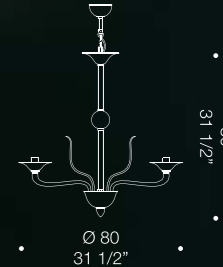

7077 K8  
8xMAX 46W E14

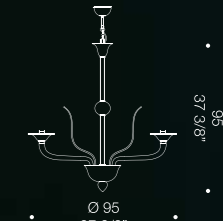

7077 K10  
10xMAX 46W E14



7077 K12  
12xMAX 46W E14



# 7079

Design by de Majo Heritage



## A great fit for all interiors.

7079 is a beautifully proportioned, handmade chandelier with a strong Venetian heritage. A perfect fit for spaces with a slightly lower ceiling, this piece is simple yet incredibly beautiful and perfect for contract projects. Available in a variety of colours and configurations, this timeless design is a staple of Italian elegance and excellence. Diameter 78cm, 88cm, 98cm and 105cm.



7079 A2  
2xMAX 46W E14

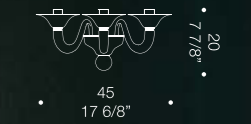

7079 A3  
3xMAX 46W E14



7079 K6  
6xMAX 46W E14

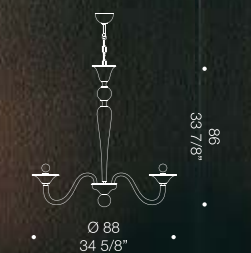

7079 K8  
8xMAX 46W E14

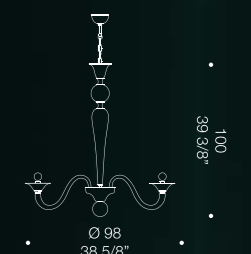

7079 K10  
10xMAX 46W E14

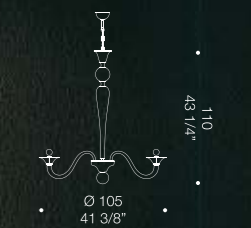

7079 K12  
12xMAX 46W E14



7079 L  
1xMAX 46W E14





# 7080

Design by de Majo Heritage



## Highly efficient, elegant piece.

7080 is a beautiful and compact chandelier which is perfect for tight spaces and contract. Featuring downward-looking arms, this small accent piece is a highly efficient lighting product, while being handmade in Murano. Available in a variety of configurations including a wall lamp version. Diameter 75cm, 85cm and 100cm.



**7080 A2**  
2xMAX 46W E14



**7080 A3**  
3xMAX 46W E14



**7080 K6**  
6xMAX 46W E14

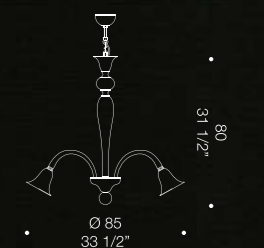

**7080 K8**  
8xMAX 46W E14

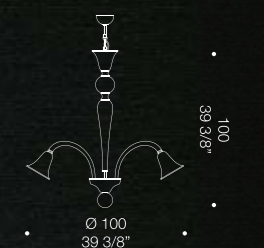

**7080 K10**  
10xMAX 46W E14



# 7081

Design by de Majo Heritage



## Antiqued, precious look.

7081 is a beautiful chandelier which features traditional glassmaking techniques, including submerging 24K gold leaf in milky white glass, to obtain a rich and elegant antiqued effect.

The harmoniously proportioned look of this piece is what makes 7081 perfect for high-end residential or hospitality projects. A timeless piece for a sophisticated interior, a heirloom for future generations to cherish.





# 7082

Design by de Majo Heritage



## Detail-centric elegance.

7082 is a simple and stylish chandelier featuring handmade coloured details on the glass lampshades. This piece has downward-looking arms, making it lighting-efficient and great for everyday use. This product was designed to fit into smaller interiors, great for contract. Highly customizable, 7082 chandelier also comes in a wall lamp configuration. Dimensions 70cm, 80cm and 100cm.

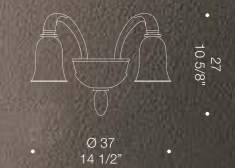

7082 A2  
2xMAX 46W E14



7082 A3  
3xMAX 46W E14



7082 K6  
6xMAX 46W E14



7082 K8  
8xMAX 46W E14

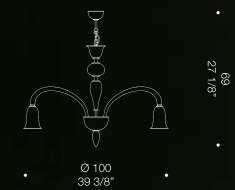

7082 K10  
10xMAX 46W E14



# 7084

Design by de Majo Heritage



## Simply elegant, rational look.

7084 is a majestic looking chandelier featuring a beautifully proportioned volume and 24K gold leaf application which adds a layer of richness to our already beautifully handcrafted glass components. This piece is fairly simple but with a great elegant look, perfect for high end projects. Highly customizable, this classical chandelier comes in several configurations including a wall lamp version. Diameter 80cm, 95cm and 110cm.

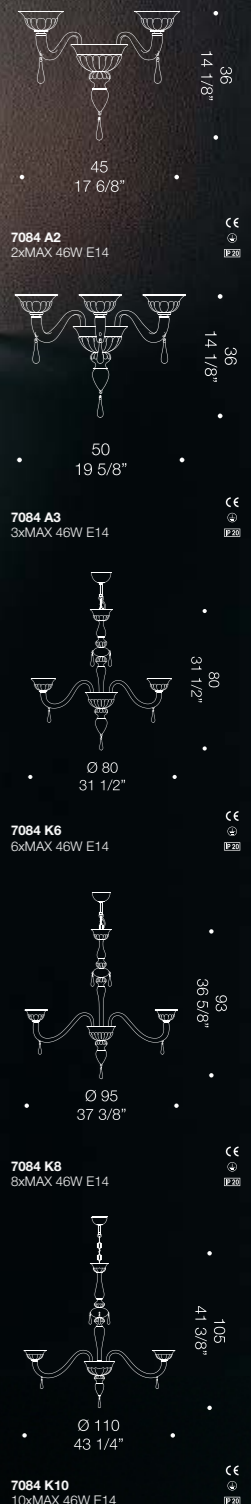



# Versatile, compact classic chandelier.

7085 is an unique chandelier which was designed to be ceiling mounted. This unique feature allows placement in interiors with a lower ceiling height. A beautifully handmade piece which is highly functional without sacrificing its timeless elegance. A best seller for a wide variety of projects. Highly customizable, this classical chandelier comes in several configurations including a wall lamp version. Diameter 80cm, 92cm and 105cm.

# 7085

Design by de Majo Heritage



# 7086

Design by de Majo Heritage

## Masterfully crafted classic.

7086 is a traditional style chandelier with a moody and dramatic look. The way this piece is proportioned suggests its placement over an important section of a residential or hospitality space. Due to its high versatility, this simple yet captivating piece is the perfect choice for a bespoke interior. A sober, timeless, elegant look which is guaranteed to draw attention. Highly customizable, this classical chandelier comes in several configurations including a wall lamp version. Diameter 90cm, 100cm and 110cm.



7086 A2  
2xMAX 46W E14



7086 A3  
3xMAX 46W E14



7086 K6  
6xMAX 46W E14



7086 K8  
8xMAX 46W E14



7086 K10  
10xMAX 46W E14



# 7087

Design by de Majo Heritage



## Simple and well balanced design.

7087 is a best seller at DE MAJO due to its simplicity and well balanced design. Many of these chandeliers are placed inside apartment homes, thanks to their compact nature and simple design. This product looks best inside a contemporary interior and is a great choice for contract projects. Cost effective, versatile and customisable - this is what makes a product stand out when picking the perfect lighting body for a client. This beautiful chandelier comes in several configurations including a wall lamp version. Diameter 85cm, 95cm and 110cm.





# 7088

Design by de Majo Heritage

## Hand-crafted elegance.

7088 is an elegant classic which thrives on timeless simplicity and versatility. Thinly crafted glass ribbons with coloured edges confer a sophisticated nuance to this piece, making it an universal staple of Venetian culture. Masterfully crafted by hand in Murano, this chandelier has well balanced proportions, resulting in a beautiful organic look. Available in several different configurations, this piece is highly customisable. Diameter 75cm, 80cm or 95cm.

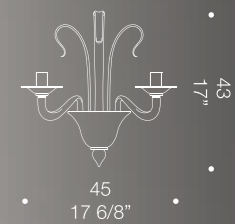

7088 A2  
2xMAX 46W E14

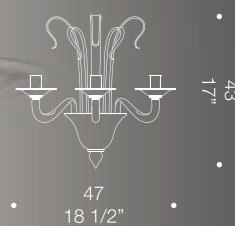

7088 A3  
3xMAX 46W E14

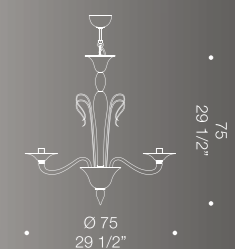

7088 K6  
6xMAX 46W E14

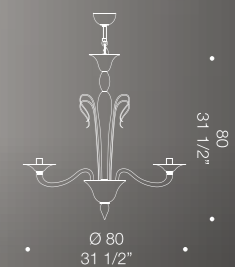

7088 K8  
8xMAX 46W E14

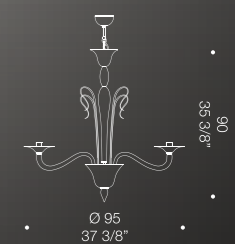

7088 K10  
10xMAX 46W E14





# 7092

Design by de Majo Heritage

## Handmade, highly decorated.

7092 is a beautifully handcrafted and highly ornate chandelier made in Murano. Featuring beautiful gold leaf decorations, this traditional style chandelier is highly sought after for its distinct elegant look. Decorating the most luxurious homes and hotels around the globe, this piece comes in several different configurations, in order for a designer to create a cohesive, timeless interior. Highly customisable.



7092 R6  
6xMAX 46W E14



7092 A2  
2xMAX 46W E14



7092 A3  
3xMAX 46W E14



7092 K6  
6xMAX 46W E14



7092 K8  
8xMAX 46W E14



7092 K10  
10xMAX 46W E14





# 7093

Design by de Majo Heritage



## Perfect accent piece for luxury.

7093 is a highly ornate chandelier handcrafted in Murano. Featuring 24k gold leaf trim and flowers, this piece is the perfect accent for an elegant and luxurious interior. Clear glass cups act as lampshades, allowing the light to travel through "rigadin" arms, creating a glowing effect throughout. This piece comes in several different configurations, and is highly customisable.

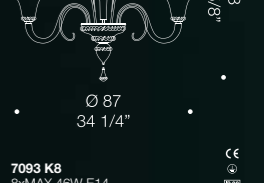
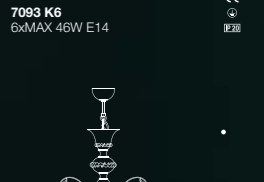
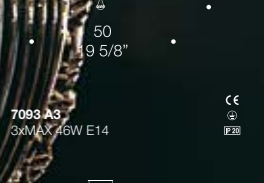
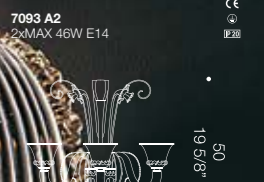



# 7095

Design by de Majo Heritage

## Unusual, highly functional.

7095 is an unique looking chandelier featuring downward-looking arms. The entire glass body is handcrafted in Murano with "rigadin" style, contributing to an elegant and timeless look, while maintaining its unprecedented form. This piece is as sophisticated as it is functional, making it the perfect choice for a darker interior. Can be ceiling mounted. Highly customisable. Diameter 50cm, height 75cm.

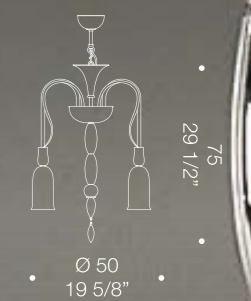

7095 K6  
6xMAX 46W E14

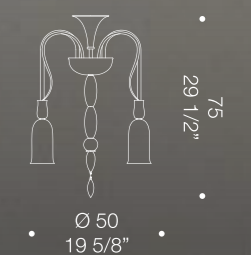

7095 P6  
6xMAX 46W E14



# 7096

Design by de Majo Heritage



## Showcasing Murano culture.

7096 is a sober, elegant chandelier with a timeless look. Decorated with simple handblown drops, this piece has embedded 24k gold leaf decorations throughout, without looking too exuberant. Available in several different configurations including wall mounted versions, the simple decor brought by this piece is nevertheless the result of handmade craftsmanship in Murano. Highly customisable. Diameter 70cm, 85cm or 100cm.





# 7098

Design by de Majo Heritage



## Ode to floral design.

7098 is a floral-inspired chandelier with an oval plan. Featuring handcrafted elements which resemble leaves, flowers and nature, this accent piece is guaranteed to start a conversation. The colourful tones, including light amethyst and ruby, contribute making this a bold statement chandelier for a variety of interiors. Huge “rigadin” style arms spread across this design, allowing to reach impressive dimensions. Area 150cm by 200cm. Also available in a round configuration and with crystal-gold leaf applications. Highly customisable and available in several different configurations.

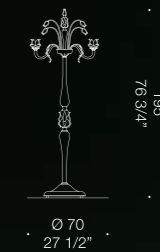

7098 R6  
6xMAX 46W E14

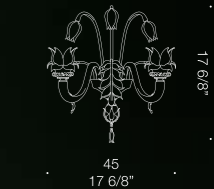

7098 A2  
2xMAX 46W E14



7098 A3  
3xMAX 46W E14

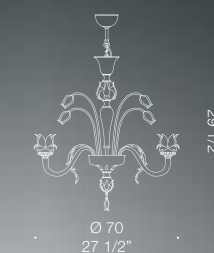

7098 K6  
6xMAX 46W E14



7098 K8  
8xMAX 46W E14

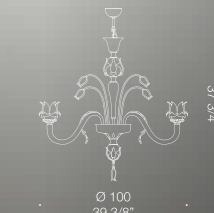

7098 K10  
10xMAX 46W E14

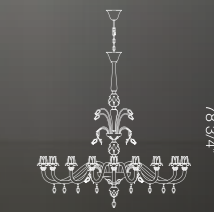

7098 K16  
16xMAX 46W E14



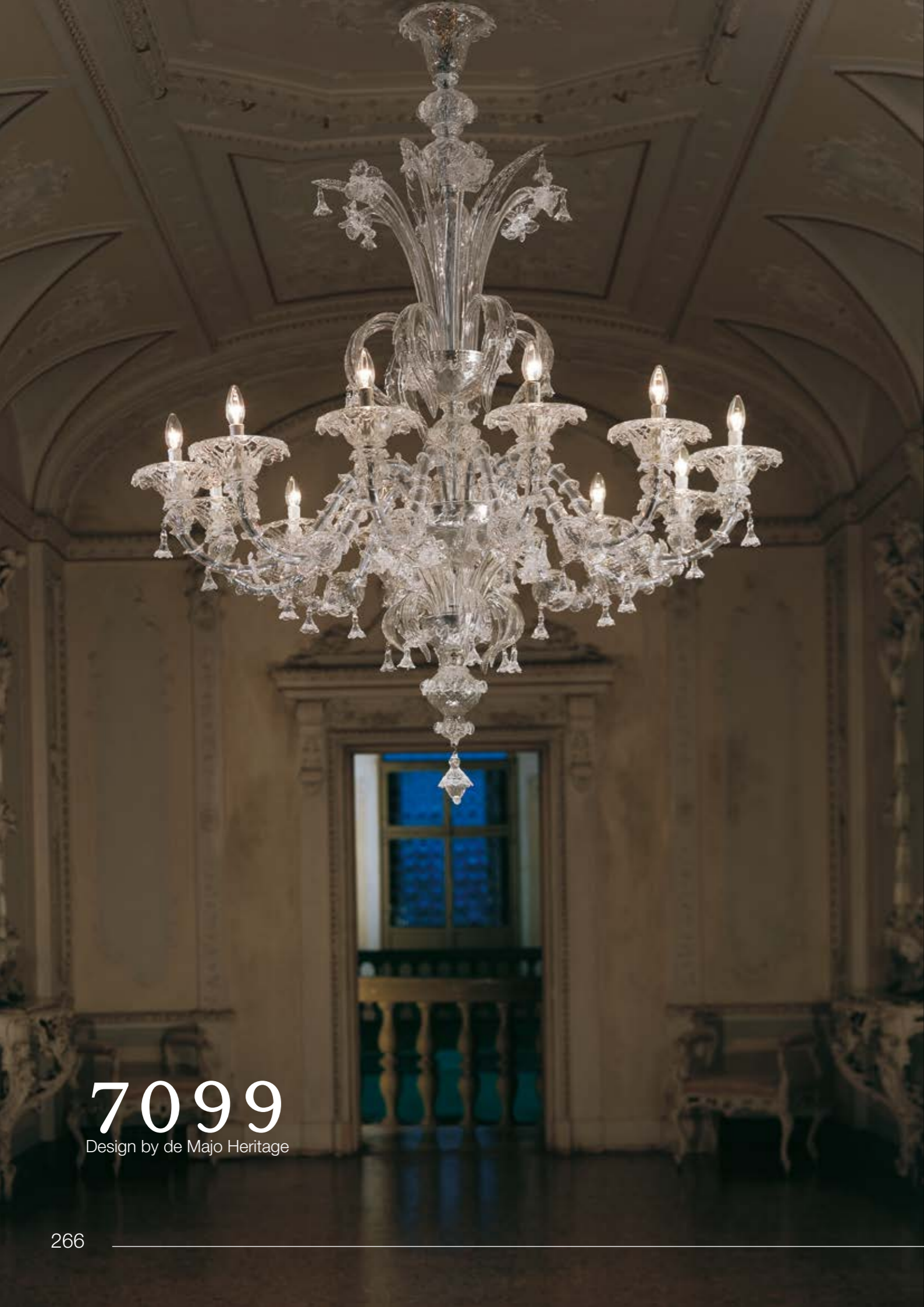

# 7099

Design by de Majo Heritage



## Highly detailed traditional piece.

7099 is a traditional Venetian chandelier which features “rezzonico” style arms and incredibly detailed ornaments. Each glass piece is handcrafted to perfection and the intricacy of the design results in a luxurious look. Looking at this piece and noticing its details is an experience.

Overall, this lighting piece looks rich and somehow alive, thanks to the shimmers of light which cross its body when lit. Also available in a wall lamp configuration. Diameter 130cm. Highly customisable.

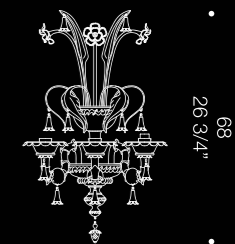

68  
26 3/4"

42  
16 1/2"

7099 A3  
3xMAX 46W E14

CE  
E28

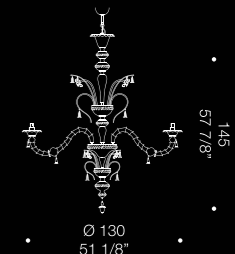

145  
57 7/8"

Ø 130  
51 1/8"

7099 K12  
12xMAX 46W E14

CE  
E28

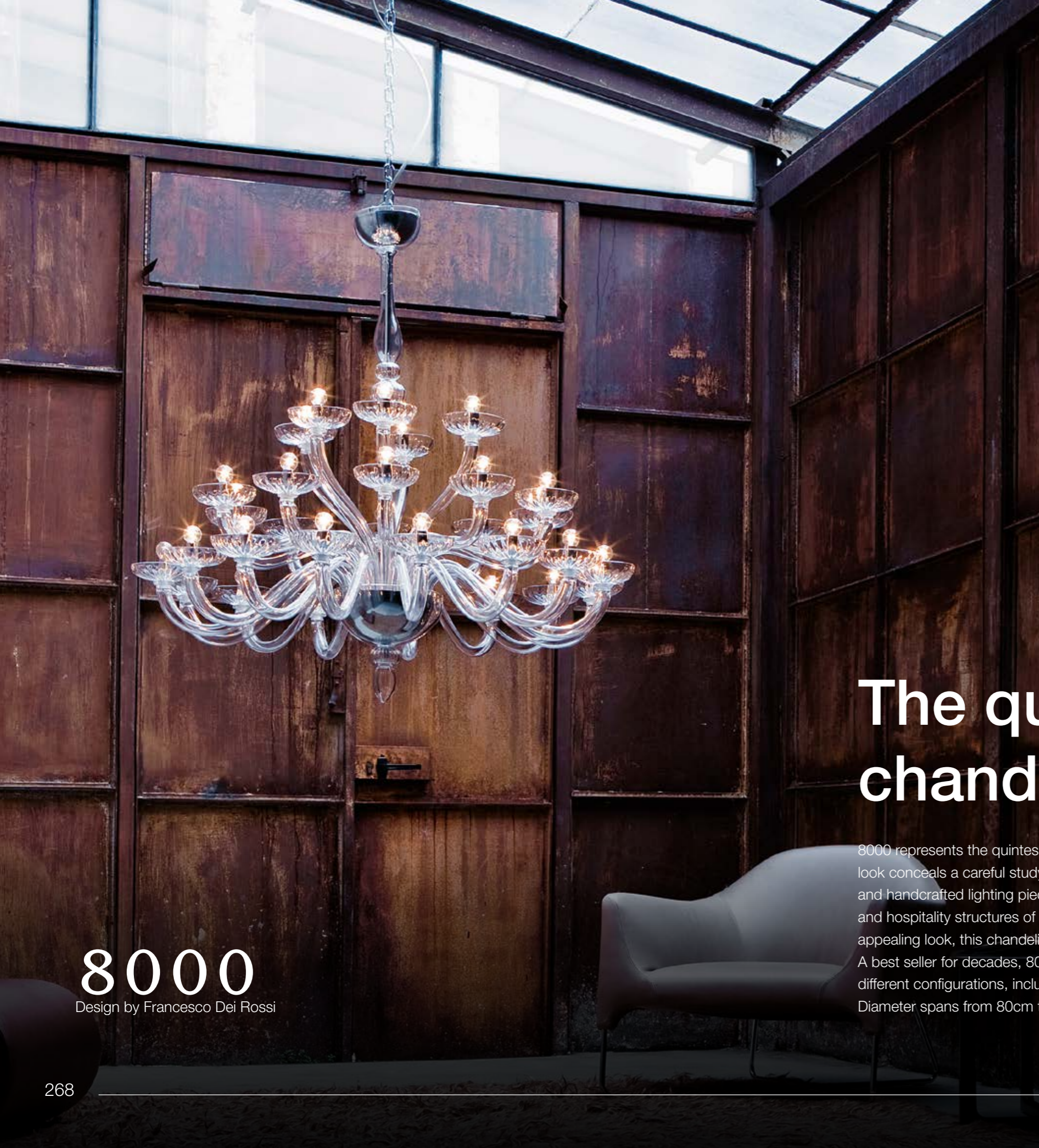

**8000**  
Design by Francesco Dei Rossi

# The quintessential chandelier.

8000 represents the quintessential chandelier. Its effortlessly sleek and elegant look conceals a careful study of proportions. The result is a beautifully designed and handcrafted lighting piece which harmoniously decorates the homes and hospitality structures of the world. Well balanced and with an universally appealing look, this chandelier is the perfect choice in a huge variety of interiors. A best seller for decades, 8000 is highly customisable and comes in several different configurations, including wall lamp versions. Diameter spans from 80cm to 160cm.

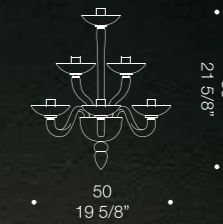

8000 A3+2+1  
6xMAX 46W E14



8000 A4+3+2  
9xMAX 46W E14



8000 K4+4  
8xMAX 46W E14

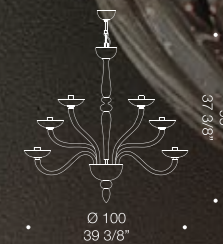

8000 K6+3+3  
12 x max 46W E14

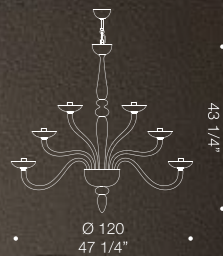

8000 K9+6+3  
18 x max 46W E14

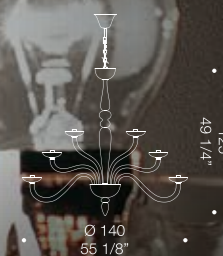

8000 K15+10+5  
30xMAX 46W E14



8000 K18+12+6+6  
42xMAX 46W E14





# 8001

Design by Francesco Dei Rossi

## Mid-century luxury aesthetic.

8001 is an elegant, timeless chandelier. Its simplicity makes it extremely versatile, while its shape recalls a traditional Venetian standard. A great choice for a mid-century style interior, as this piece recalls authentic heritage traits. The stock version comes in glossy white finish with 24K gold leaf, which confers a somewhat antiqued finish, while shimmering. Highly customisable, 8001 comes in several different configurations, including wall lamp versions. Diameter spans from 80cm to 130cm.







# 8002

Design by Francesco Dei Rossi



## Plain simplicity with a coloured touch.

8002 is a simple, elegant chandelier with a touch of colour. The ideal choice when in need of a sober accent piece for a sleek interior. Its well balanced design makes it incredibly versatile, allowing this piece to look great in a modern interior as well as a classical one. Its cups are shaped in an unique fashion, and slightly decorated. Highly customisable, 8002 comes in several different configurations, including wall lamp versions. Diameter spans from 80cm to 105cm.

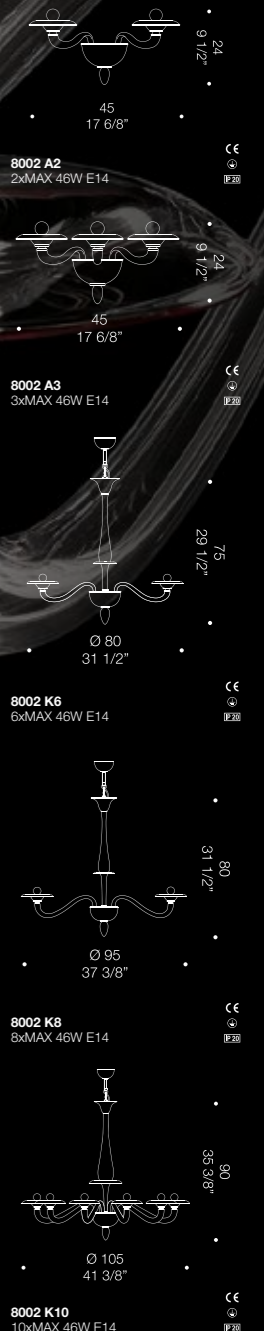



# Formally elegant, unique looking.

8003 is an unique looking chandelier which is highly functional while being compact. The exclusive design of this piece is highly captivating and guarantees great lighting. The entire piece is handcrafted in Murano using "rigadin" style, which results in an elegantly ornate body, creating a captivating light play. A great choice for tight, darker spaces, this chandelier is highly customisable. Diameter 50cm.

# 8003

Design by Francesco Dei Rossi

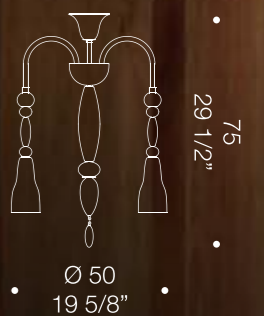

8003 K6  
6xMAX 46W E14

CE  
E28

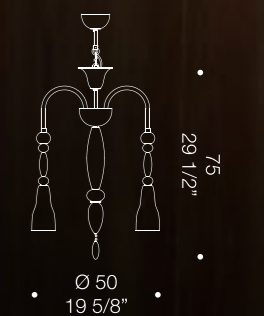

8003 K6  
6xMAX 46W E14

CE  
E28



# 8004

Design by de Majo Heritage

## Astonishing craftsmanship.

8004 is a traditional style chandelier with incredibly beautiful details. Featuring a double glass cup and "rigadin" style arms, the floral patterns of this piece are truly astonishing. It comes in a beautiful colour palette including amethyst and aquamarine, enriched with 24k gold leaf applications throughout. This majestic piece is the perfect choice for a luxurious, traditional interior. Entirely handmade in Murano, 8004 is a masterpiece of craftsmanship, featuring unique glassmaking techniques which make this product stand out. Available in several different configurations including wall lamp versions. Diameter spans from 83cm to 130cm.

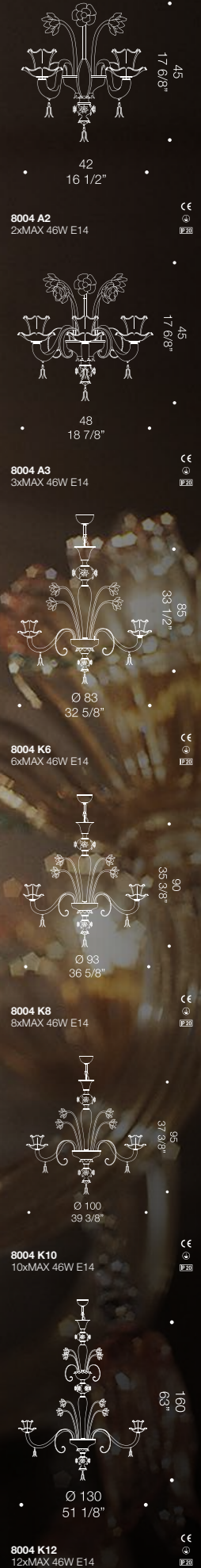



# 8006

Design by de Majo Heritage

## Proportioned to perfection.

8006 is a compact, elegant chandelier featuring “rigadin” style patterns throughout. This piece does not have arms like a traditional chandelier would, instead, it connects to the cups through a hollow decorative glass leaf, seamlessly combined and proportioned to perfection. A great choice for a tight space in homes or hospitality structures. Also available in a wall lamp configuration, this piece is highly customisable. Diameter 60cm or 65cm.

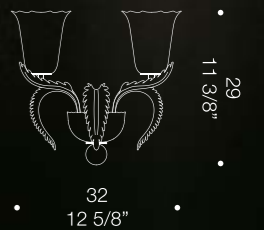

8006 A2  
2xMAX 46W E14



8006 A3  
3xMAX 46W E14

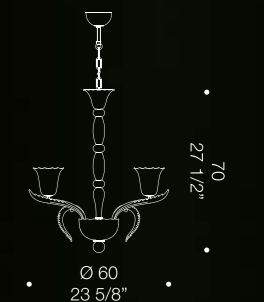

8006 K6  
6xMAX 46W E14

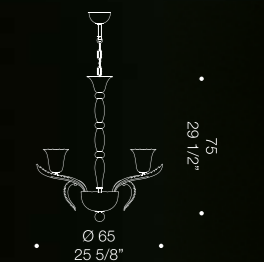

8006 K8  
8xMAX 46W E14



# A Venetian heritage piece.

# 8010-8011-8012

Design by de Majo Heritage

8010-8011-8012 are elegant, traditional style ceiling lamps with a variety of decorations and features, among which 24k gold leaf applications and milk white trims. These pieces are the ideal lighting products for interiors with a lower ceiling height, allowing a beautifully handcrafted piece to shine over an elegant and sophisticated room. Highly customisable. Diameter 55cm, height 50cm



8012 P6  
6xMAX 46W E14

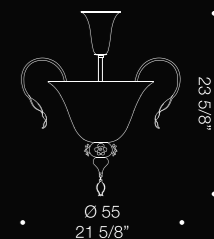

8011 P6  
6xMAX 46W E14

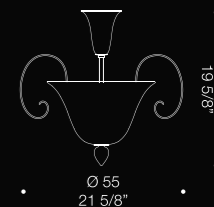

8010 P6  
6xMAX 46W E14





# 8020

Design by Francesco Dei Rossi



## Glossy, milky white finish.

8020 is a majestic glass working creation characterised by a milky white finish, which results in a glossy, captivating feel. While the decorations are simple, the “rigadin” style arms and body confer a slight sense of classical taste, without sacrificing the modern look to this piece. Highly modular and easily configurable, this chandelier is a great choice when in need of a big lighting piece for a grand hall. The result is a well balanced, proportioned statement piece which looks timelessly contemporary. Dimensions range between a diameter of 180cm and height of 90cm, to a diameter of 200cm and a height of 300cm.

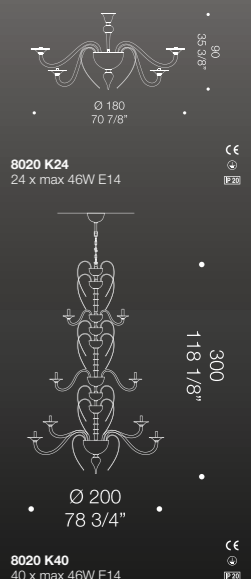



# A deconstructed classic.

8080 is often referred to as a deconstructed chandelier. The design fundamentals of the classic Venetian chandelier can be found in this design, however, the linear configuration of this product shows a new concept, which is not only visually pleasant, but very functional in many interiors. This product is available in two main shapes: toroidal or linear. In both cases, the "modularity" of this piece makes it a true asset when in need of a tailored dimension. Available in custom finishes and sizes.

# 8080

Design by Francesco Dei Rossi

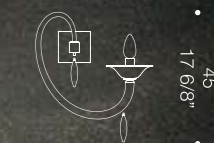

40  
15 3/4"

8080 A1  
1xMAX 46W E14

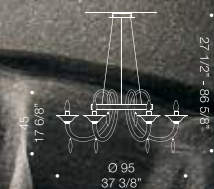

8080 K6  
6xMAX 46W E14

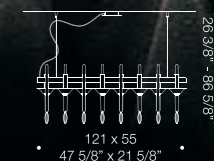

8080 K8  
8 x max 46W E14

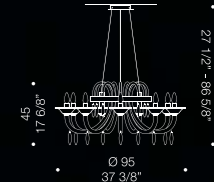

8080 K9  
9xMAX 46W E14

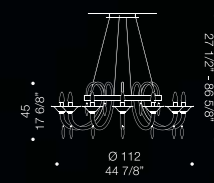

8080 K12  
12xMAX 46W E14

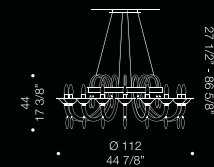

8080 K16  
16xMAX 46W E14





8080

Design by Francesco Dei Rossi



# 8089

Design by Francesco Dei Rossi



## A floral masterpiece.

8089 is a fascinating chandelier with floral designs. One of the peculiarities of this piece is the orientation the arms, blossoming like wild flowers in every direction, which communicates the thriving strength of nature. A perfect centerpiece for big dining halls, as well as hospitality interiors. It features textured arms which Venetians call "rigadin" style. Easily one of the most beautiful and elegant pieces of this collection. Available in several different configurations, finishes and sizes, including a 150cm diameter, 200cm height version.



70  
27 1/2"

50  
19 5/8"

8089 A3  
3xMAX 46W E14

CE  
E20



170  
67"

Ø 130  
51 1/8"

8089 K9  
9xMAX 46W E14

CE  
E20



200  
78 3/4"

Ø 150  
59"

8089 K12  
12xMAX 46W E14

CE  
E20



# Functional concept for any interior.

8090 is often referred to as a deconstructed chandelier. The linear configuration of this product shows a new concept, which is not only visually pleasant, but very functional in many interiors. This product is available in two main shapes: toroidal or linear. In both cases, the “modularity” of this piece makes it a true asset when in need of a tailored dimension. Featuring ornate details such as “rigadin” style glass drops, smooth arms and an exclusive handmade glass element underneath the lampshades, this piece is a sophisticated option for a mid-century style interior. Available in custom finishes and sizes.

# 8090

Design by Francesco Dei Rossi

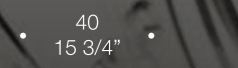
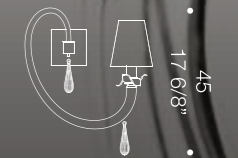

8090 A1  
1xMAX 46W E14

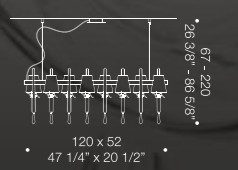

8099 K8  
8xMAX 46W E14



# 8090

Design by Francesco Dei Rossi

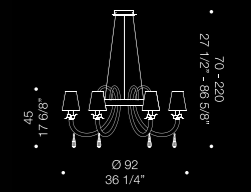

**8089 K6**  
6xMAX 46W E14

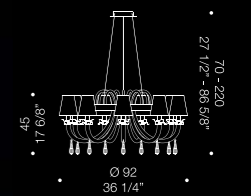

**8090 K9**  
9xMAX 46W E14

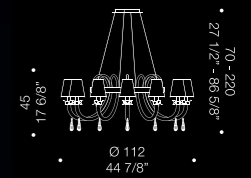

**8090 K12**  
12xMAX 46W E14

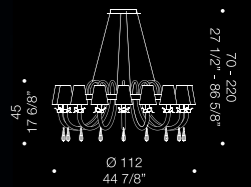

**8090 K16**  
16xMAX 46W E14

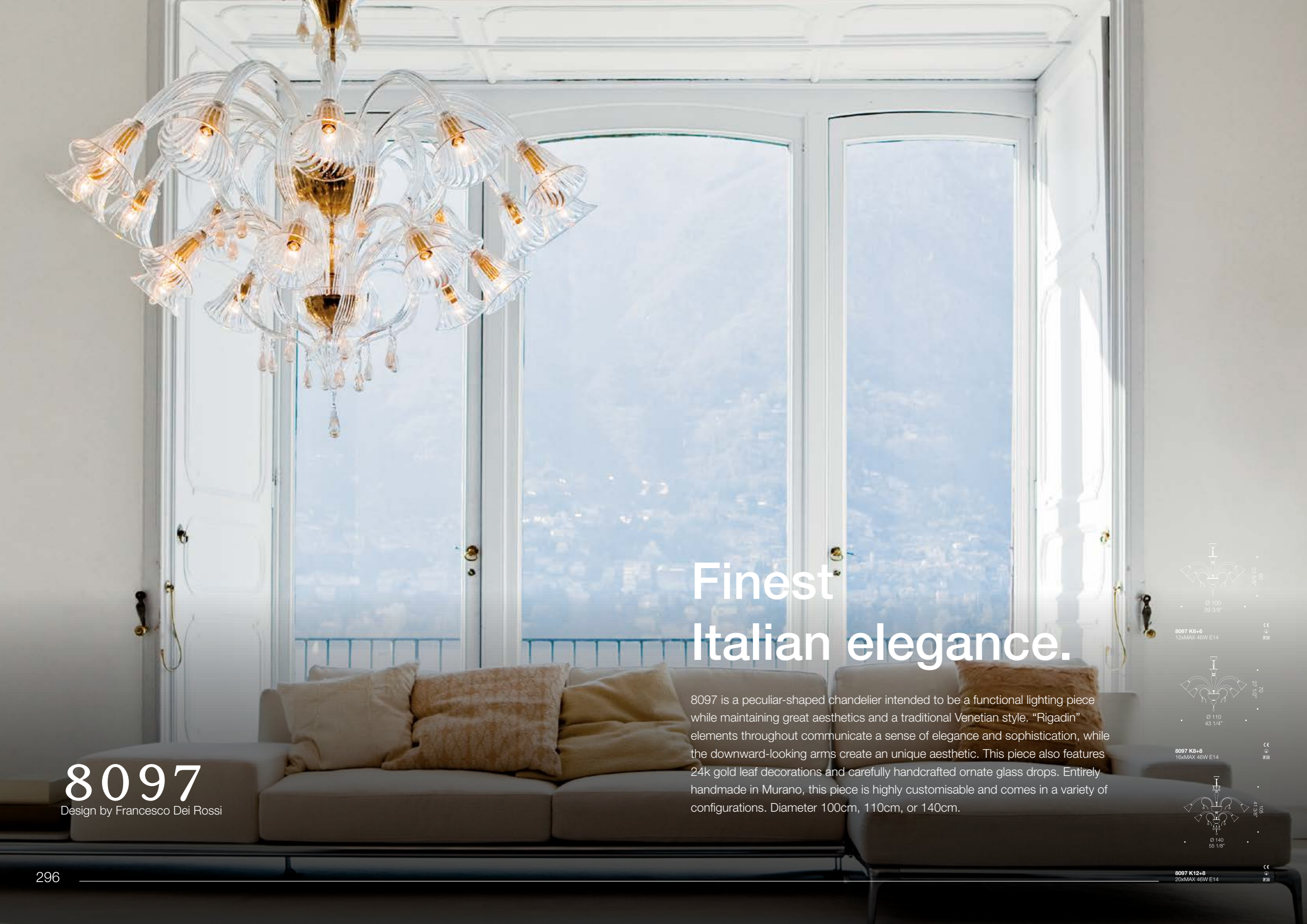

# Finest Italian elegance.

# 8097

Design by Francesco Dei Rossi

8097 is a peculiar-shaped chandelier intended to be a functional lighting piece while maintaining great aesthetics and a traditional Venetian style. "Rigadin" elements throughout communicate a sense of elegance and sophistication, while the downward-looking arms create a unique aesthetic. This piece also features 24k gold leaf decorations and carefully handcrafted ornate glass drops. Entirely handmade in Murano, this piece is highly customisable and comes in a variety of configurations. Diameter 100cm, 110cm, or 140cm.





# Authentic Venetian luxury.

8099 is a traditional Venetian style chandelier which features stunning details and a very high level of craftsmanship. A true masterpiece for a luxurious, traditional interior. "Rigadin ritorto" style arms and cups contribute to communicate extreme opulence, as well as beautifully crafted charms which dangle from each arm. Each component is deliberately designed with intricacy, resulting in a piece which is truly entertaining for the eye. The masterfully crafted details in this beautiful chandelier make it stand out and are inimitable. Available in custom finishes and sizes, as well as several different configurations including wall lamp versions.

# 8099

Design by de Majo Heritage

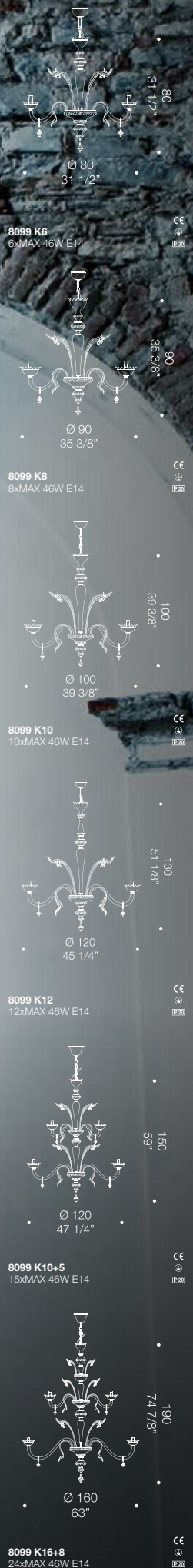



# 8099

Design by de Majo Heritage

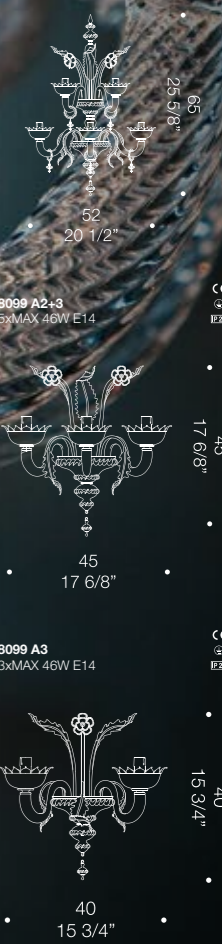

# 9001

Design by de Majo Heritage

## Timeless feeling of elegance.

9001 is a classical lighting series which decorates the most elegant homes and hospitality structures. The antiqued amber finish, with "rigadin" style details, confer a timeless luxury feel to this piece. This product comes in several different configurations, which range from floor lamp, table lamp, ceiling lamp, to wall lamp. A true Venetian staple which is entirely handmade in Murano, guaranteeing design authenticity and quality. Highly customisable.

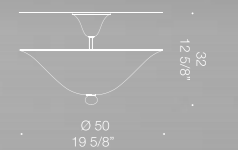

9001 P0  
3xMAX 77W E27

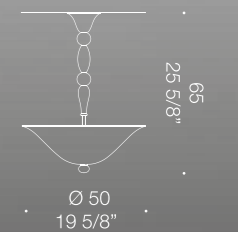

9001 S0  
3xMAX 77W E27

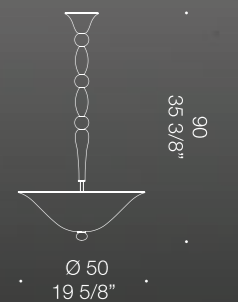

9001 S1  
3xMAX 77W E27





# 9001

Design by de Majo Heritage

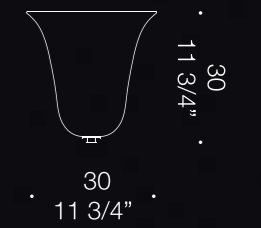

9001 A0  
1xMAX 77W E27

CE

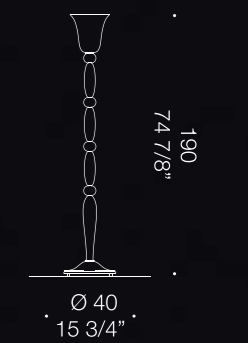

9001 R0  
1xMAX 150W E27

CE

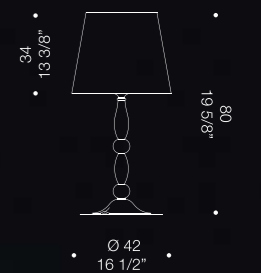

9001 T  
1xMAX 77W E27

CE



# Authentic Venetian lighting heritage.

9002 is a classical lighting series which is heavily inspired by authentic Venetian lighting heritage. Decorating the most elegant homes and hospitality structures of the world, this collection includes ceiling lamps, a floor lamp and a table lamp. The simple design behind this product is the result of a careful study of proportions, resulting in a sinuous and sleek piece which features “rigadin” details and a glossy milk white finish. Highly customisable.

# 9002

Design by de Majo Heritage

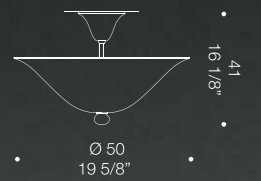

9002 P0  
3xMAX 77W E27

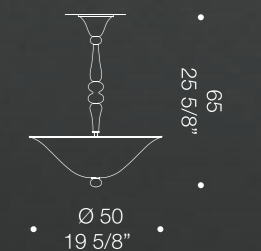

9002 S0  
3xMAX 77W E27

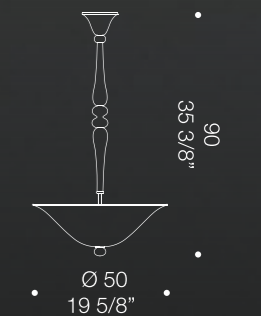

9002 S1  
3xMAX 77W E27

# 9002

Design by de Majo Heritage

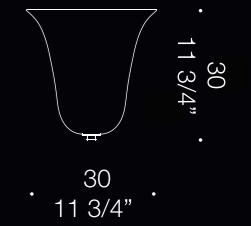

9002 A0  
1xMAX 77W E27

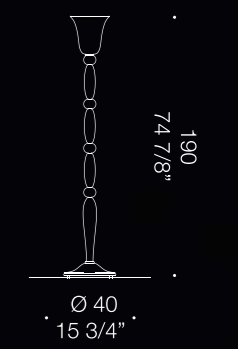

9002 R0  
1xMAX 150W E27

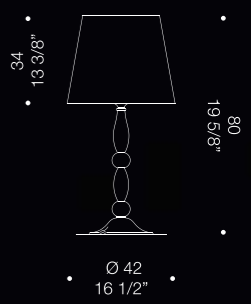

9001 T0  
1xMAX 77W E27

