



news23

 **contardi**

**indoor**

**B** 8 BAGGY  
22 BIANCA

**F** 32 FLY

**K** 48 KIKI

**S** 64 STICK

**outdoor**

**C** 78 CLARA

**F** 88 FLY OUTDOOR

Lampade a sospensione  
Suspensions

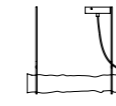

Baggy  
8

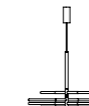

Bianca  
22

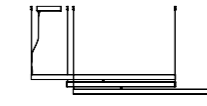

Fly  
32



Kiki  
48

Lampade a parete  
Wall lights



Bianca  
22



Fly  
32



Kiki  
48



Stick  
64

Lampade da terra  
Floor lamps



Baggy  
8



Fly  
32



Stick  
64

Lampade da tavolo  
Table lamps



Baggy  
8



Kiki  
48

Lampade a batteria  
Battery lamps

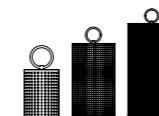

Clara  
78

Lampade outdoor  
Outdoor lamps

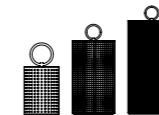

Clara  
78



Fly outdoor  
88

Le immagini sono inserite al solo scopo illustrativo. Le nostre finiture sono il risultato di delicati processi di lavorazione artigianale. Piccole differenze e imperfezioni non devono essere considerate difetti ma caratteristiche tipiche del prodotto, nonché garanzia di alta qualità ed unicità.

Images are for illustrative purpose only. Our finishes are the result of delicate handcraft processes. Small differences and imperfections should not be considered as defects but as specific traits of the products, as well as the guarantee of their high quality and uniqueness.

INDOOR  
COLLECTION



# MATERIALS AND COLOURS

INDOOR COLLECTION

## Struttura / Frame

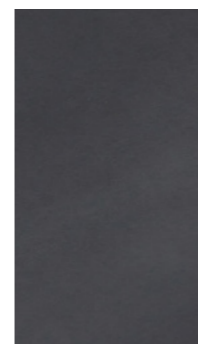

Antracite  
*Anthracite*

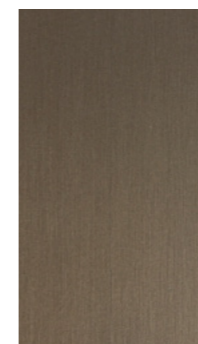

Bronzo-nickel  
satinato / *Brushed  
bronze-nickel*

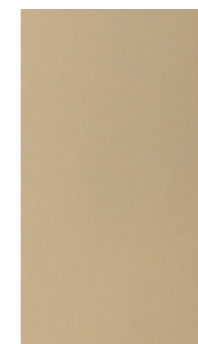

Laccato oro  
*Gold lacquered*



Nickel dorato  
satinato / *Satin  
golden nickel*

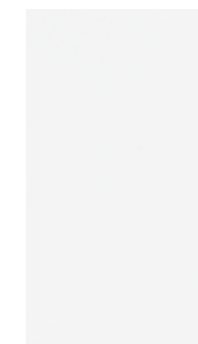

Laccato bianco  
opaco / *Matt  
white lacquered*



Rame satinato  
*Satin copper*

## Diffusore / Diffuser

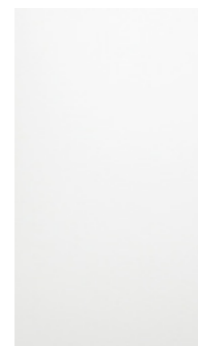

Vetro bianco opale  
*Opal white glass*



Policarbonato  
bisatinato / *Dual  
satin polycarbonate*



Plexiglass rigato  
*Striped plexiglass*

## Accessori / Accessories



Corda in tessuto  
color bianco/grigio  
*White/grey colour  
fabric rope*



Cavo in tessuto  
color arancio  
*Orange colour  
fabric cable*



Cavo in tessuto  
color sabbia  
*Sand colour  
fabric cable*



Cavo in tessuto  
color nero  
*Black colour  
fabric cable*



# BAGGY

PAOLA NAVONE - OTTO STUDIO





**“Baggy** è il risultato di un’alchimia irripetibile tra il nostro modo di progettare e Contardi. In modo molto speciale, e con sapienza, Contardi ha assecondato l’attitudine all’imperfezione del nostro approccio al design, accettando di declinare la rigorosa essenza tecnica che le appartiene in un progetto di lampade dall’equilibrio effimero e dall’aria ironica.”

*“**Baggy** is the result of an irreplicable alchemy between our way of designing and Contardi. In a very special and pertinent way, Contardi has fostered the aptitude for imperfection in our design approach, accepting an interpretation of the company’s rigorous essence, in a project of lamps of ephemeral balance and an air of irony.”*

**Paola Navone - Otto Studio**





Sospensione versione "Orizzontale"  
"Horizontal" suspension version



Sospensioni versioni "Verticale" e "Orizzontale"  
"Vertical" and "Horizontal" suspension versions





Sospensioni versioni "Verticale" e "Orizzontale"  
"Vertical" and "Horizontal" suspension versions





Lampade da tavolo versioni "Trio", "Small" e "Medium"  
 "Trio", "Small" and "Medium" table lamp versions



Lampada da tavolo versione "Trio"  
 "Trio" table lamp version

Baggy è una collezione di lampade dal mood informale e giocoso.  
 Ogni lampada Baggy è composta da moduli singoli di diverse misure che consentono  
 totale libertà compositiva.

*Baggy is a collection of lamps with an informal and playful mood.  
 Each Baggy lamp is composed of individual modules of different sizes that allow total  
 freedom of composition.*





Lampada da terra versione "Trio"  
"Trio" floor lamp version



Lampada da terra versione "Trio"  
"Trio" floor lamp version

Il diffusore in policarbonato bisatinato ha l'aspetto irregolare di un tubo di carta stropicciato. La corda tessile e morbida, dettaglio in linea con il codice stilistico archi-decorativo del brand, sostiene la lampada nella versione sospesa e diventa elemento di unione per le versioni da tavolo e terra.

*The dual satin polycarbonate diffuser has the irregular appearance of a crumpled paper tube. The soft textile cord, a detail in line with the brand's archi-decorative stylistic code, supports the lamp in the suspended version and becomes a joining element for the table and floor versions.*





### Sospensioni / Suspensions

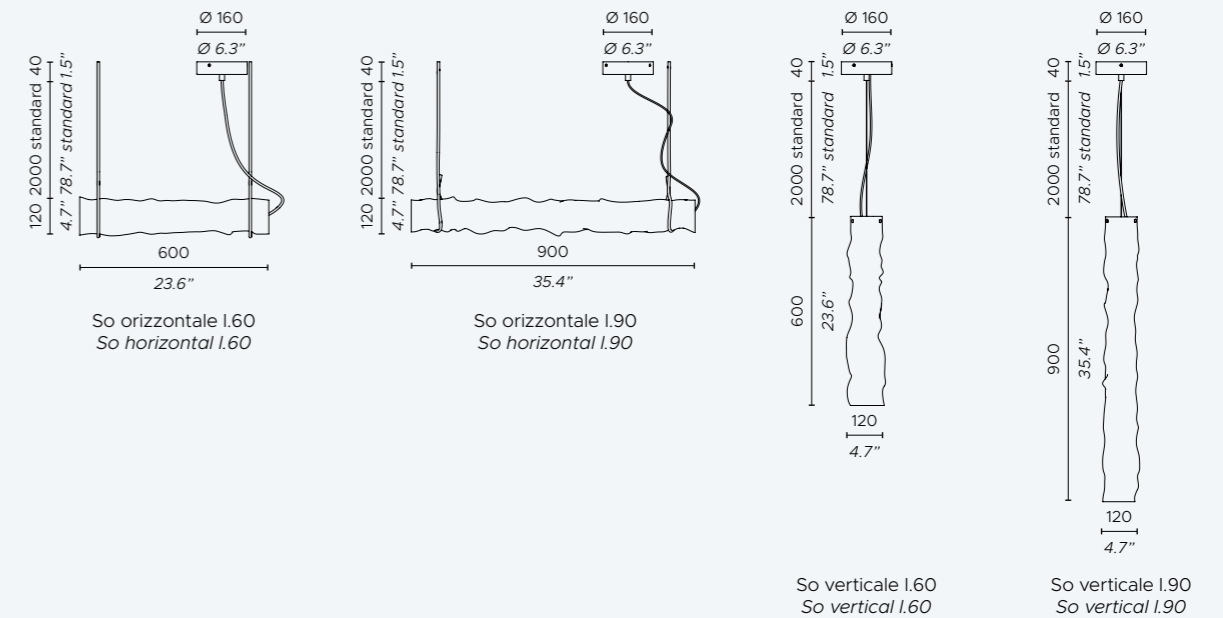

### Lampada da terra / Floor lamp

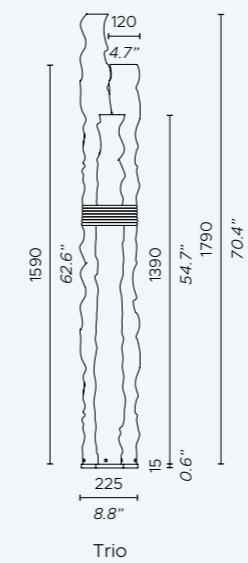

### Lampade da tavolo / Table lamps

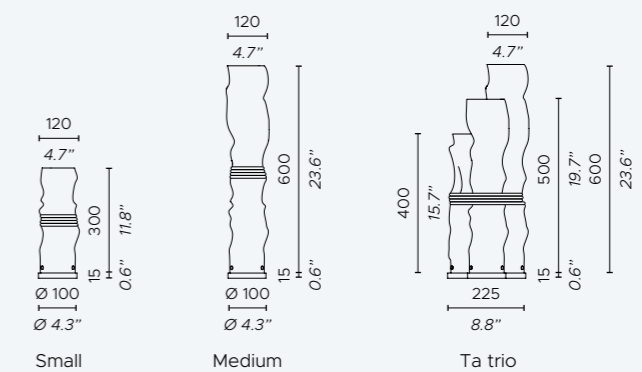

### Diffusore / Diffuser

 Policarbonato bisatinato  
Dual satin polycarbonate

### Fonte luminosa / Light source

**220 - 240V:**  
So - FI - Ta Custom Strip LED 15W/m

**So**  
Dimmerazione a taglio di fase/Triac - altri sistemi di dimmerazione (DALI e 1-10V) disponibili su richiesta  
Phase cut/Triac dimming - alternative dimming systems (DALI and 1-10V) available on demand

**FI**  
Dimmerabile a piede / Dimmable with foot control

**Ta**  
Dimmerabile con interruttore su cavo  
Dimmable with switch on cable

### Accessorio / Accessory

 Corda in tessuto color bianco/grigio  
White/grey colour fabric rope

**110V:**  
So - FI - Ta Custom Strip LED 15W/m

**So**  
Dimmerazione a taglio di fase/Triac - sistema di dimmerazione 1-10V disponibile su richiesta  
Phase cut/Triac dimming - 1-10V dimming system available on demand

**FI**  
Dimmerabile a piede / Dimmable with foot control

**Ta**  
Dimmerabile con interruttore su cavo  
Dimmable with switch on cable

# BIANCA

DAINELLI STUDIO







“La collaborazione con Contardi ha preso da subito un ritmo inaspettato. La nostra creatività, insieme alla loro esperienza nel trovare la migliore soluzione tecnica per ottenere l'effetto luminoso desiderato, ci ha permesso di realizzare un prodotto unico, funzionale, dall'estetica accattivante: **Bianca**. Un incontro per noi prezioso nel mondo dell'illuminazione.”

*“The collaboration with Contardi immediately took on an unexpected rhythm. Our creativity, together with their experience in finding the best technical solution to achieve a desired lighting effect, has allowed us to generate a unique, functional product with a captivating image: **Bianca**. An encounter in the world of lighting that has been very precious for us.”*









Lampada a parete  
Wall light

Prodotto il cui design si ispira alla struttura del fiocco di neve.  
Bianca è una lampada composta da moduli irregolari, disposti secondo una sequenza precisa si da garantirne la stabilità sia nella versione applique, sia a sospensione.

*A product whose design is inspired by the structure of the snowflake.  
Bianca is a lamp composed of irregular modules, arranged in a precise sequence so as to guarantee its stability in both the wall and pendant versions.*



Lampade a parete  
Wall lights



**Lampade a parete / Wall lights**

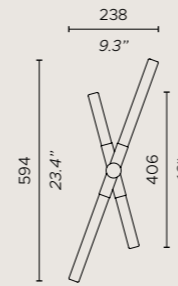

Senza base - driver remoto  
Without base - remote driver  
110V version: supplied with plate to cover junction box



Con base - driver integrato  
With base - driver on board  
110V version: supplied with plate to cover junction box

**Sospensioni / Suspensions**

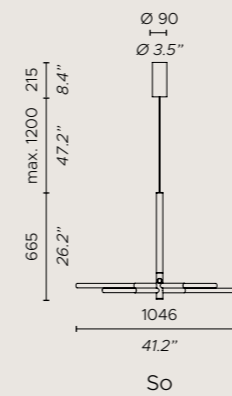

So

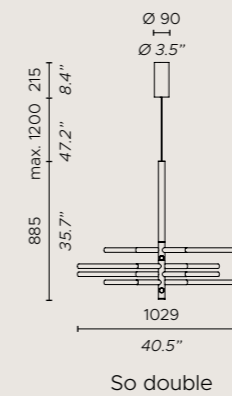

So double

**Struttura / Frame**

- Antracite  
Anthracite
- Laccato oro  
Gold lacquered

**Diffusore / Diffuser**

- Vetro bianco opale  
Opal white glass

**Fonte luminosa / Light source**

**220 - 240V:**

**Ap** 2 x 5W LED + 2 x 8W LED  
sorgente luminosa inclusa / light source included

**So** 2 x 5W LED + 2 x 8W LED + 2 x 10W LED  
sorgente luminosa inclusa / light source included

**So double** 4 x 5W LED + 4 x 8W LED + 4 x 10W LED  
sorgente luminosa inclusa / light source included

**Ap - So - So double**

Dimmerazione a taglio di fase/Triac - altri sistemi di dimmerazione (DALI e 1-10V) disponibili su richiesta  
Phase cut/Triac dimming - alternative dimming systems (DALI and 1-10V) available on demand

**110V:**

**Ap** 2 x 5W LED + 2 x 8W LED  
sorgente luminosa inclusa / light source included

**So** 2 x 5W LED + 2 x 8W LED + 2 x 10W LED  
sorgente luminosa inclusa / light source included

**So double** 4 x 5W LED + 4 x 8W LED + 4 x 10W LED  
sorgente luminosa inclusa / light source included

**Ap - So - So double**

Dimmerazione a taglio di fase/Triac - sistema di dimmerazione 1-10V disponibile su richiesta  
Phase cut/Triac dimming - 1-10V dimming system available on demand



FLY

MASSIMILIANO RAGGI







“Mi lega a Contardi un rapporto professionale, di affetto e amicizia che dura da più di quindici anni.

Sono cresciuto insieme al brand, ne ho seguito lo sviluppo contribuendo ad esaltarne le caratteristiche, il codice estetico archi-decorativo e avvicinandolo progressivamente all’universo del lighting design di cui **Fly** rappresenta il mio contributo per la collezione.”

*“I am linked to Contardi by a professional relationship, of fondness and friendship, which has lasted for over 15 years. I have grown up together with the brand, watching its growth and contributing to bring out its characteristics, its archi-decorative aesthetic code, gradually bringing it into the universe of lighting design, where **Fly** represents my contribution for the Collection.”*

**Massimiliano Raggi**





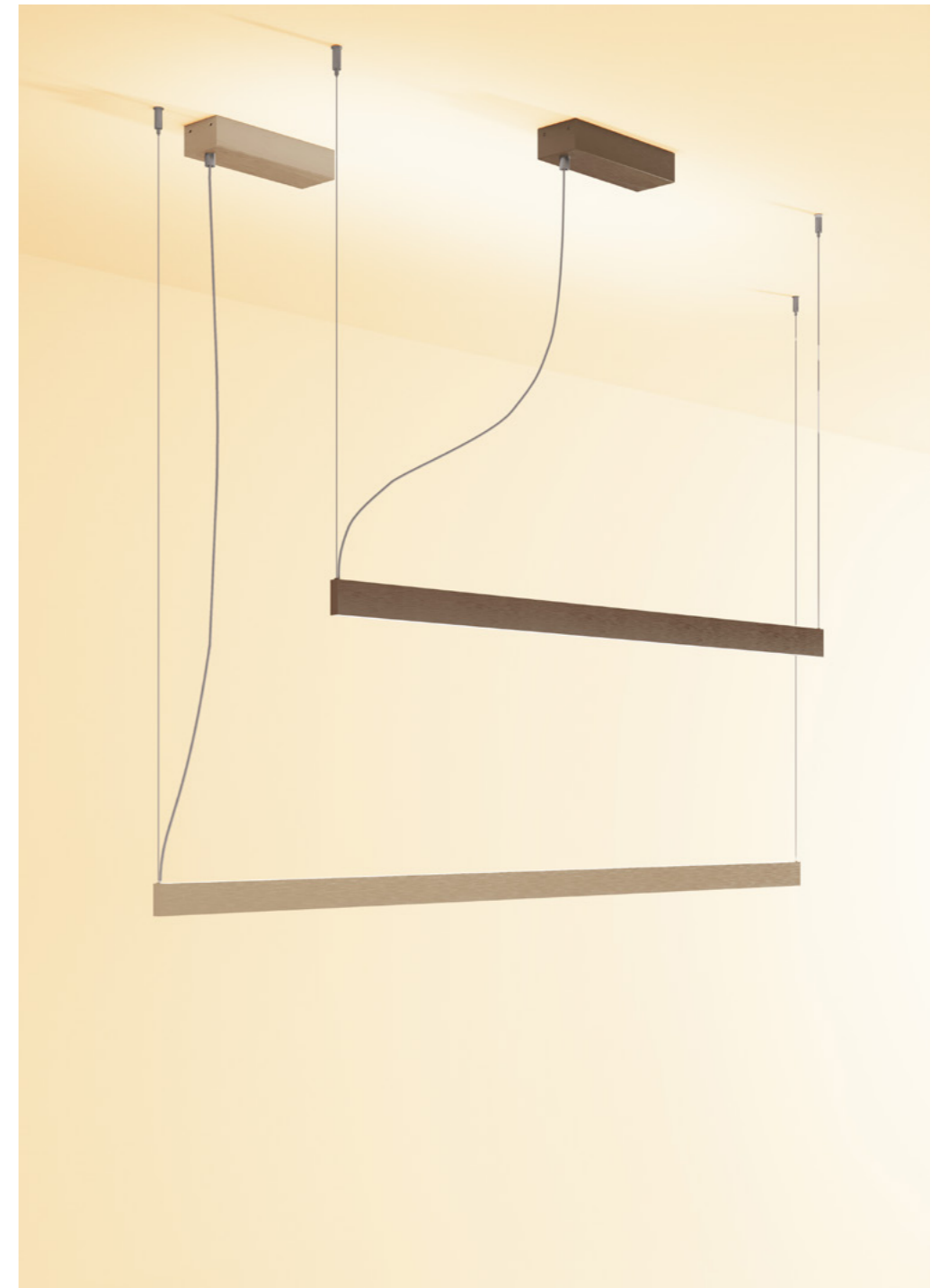
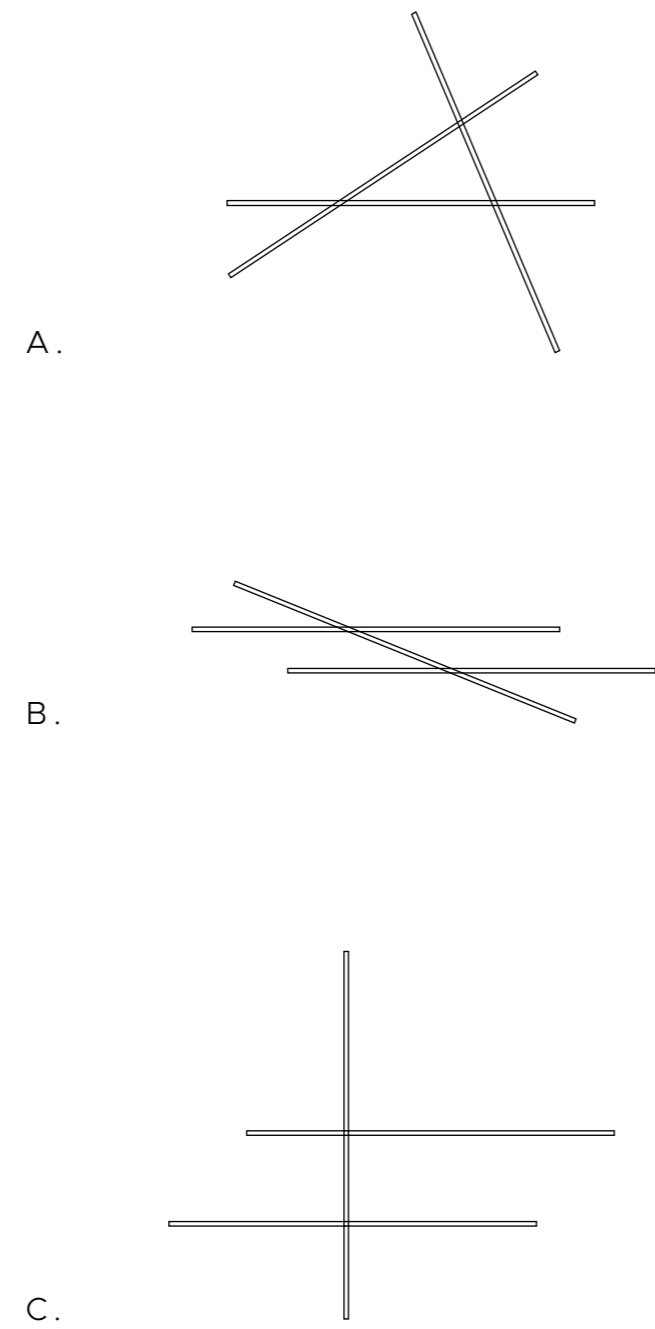
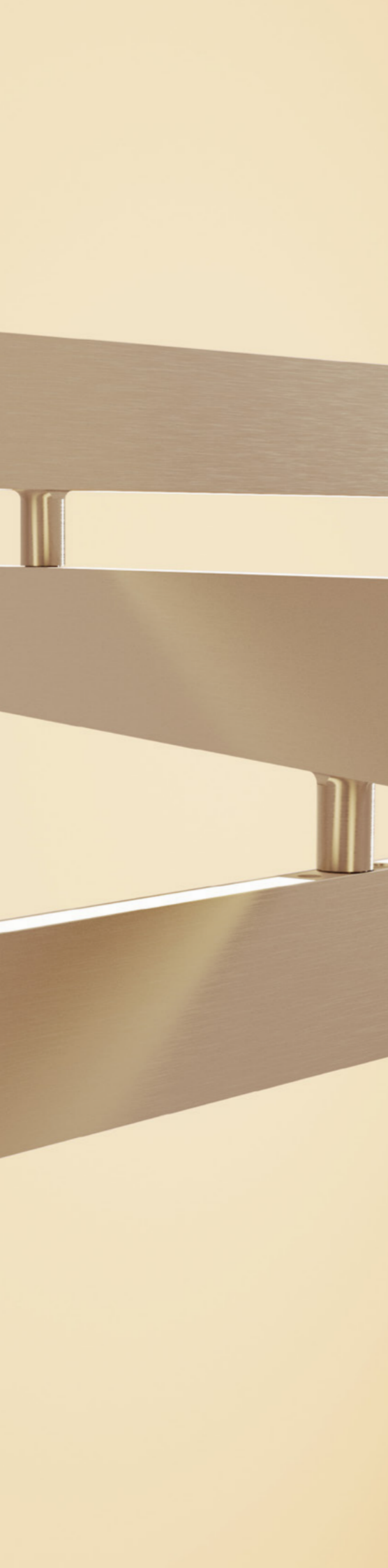

Sospensioni versioni "Linear"  
"Linear" suspension versions





Lampade da terra versioni "FI" e "Long"  
"FI" and "Long" floor lamp versions

Fly nasce dal desiderio progettuale di realizzare un prodotto dalla forza espressiva decisa e al tempo stesso leggera, come un tratto di matita che percorre longitudinalmente la superficie di un foglio bianco. Un segno grafico le cui proporzioni affermano l'identità di una struttura ortogonale che diventa essenziale scultura luminosa.

*Fly was born from the desire to design a product with a strong expressive force and at the same time light, like a pencil that runs longitudinally along the surface of a white sheet. A graphic sign whose proportions affirm the identity of an orthogonal structure that becomes essential luminous sculpture.*



Lampada da terra versione "Long"  
"Long" floor lamp version





Lampada da terra versione **"Torch"** - Luce posteriore verticale e superiore indiretta  
**"Torch"** floor lamp version - Vertical back and upper indirect light

Attraverso un processo di sottrazione il corpo luminoso, quando acceso, scompare, rivelando la sola presenza della luce. Il profilo bifacciale, nella sua semplicità, permette di orientare la luce ed enfatizzarla a seconda del taglio dalla quale emana, distribuendola nell'ambiente in modo puntuale e sofisticato.

*Through a process of subtraction the luminous body, when turned on, disappears, revealing the mere presence of light. The double-sided profile, in its simplicity, allows to orient the light and emphasize it depending on the cut from which it emanates, distributing it in a timely and sophisticated way.*



Lampade a parete versione **"Remote"** - driver remoto  
**"Remote"** wall light version - remote driver

## Sospensioni / Suspensions

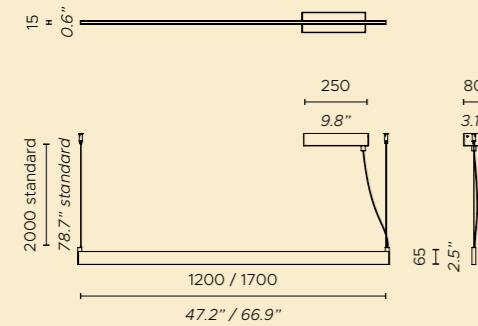

Linear I.120 / I.170

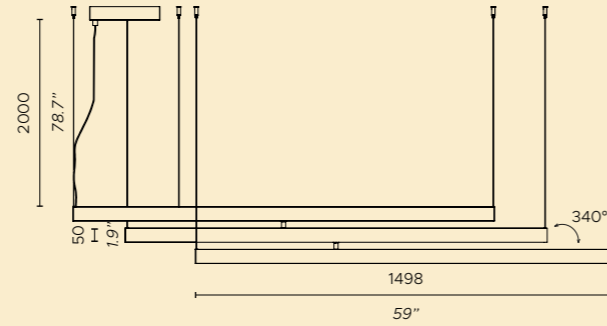

Multipla / Multiple

## Lampada a parete / Wall light

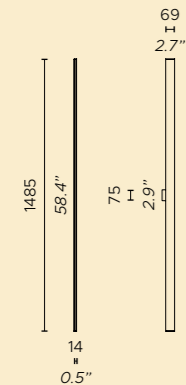

Remote

## Accessorio "Remote" / "Remote" accessory

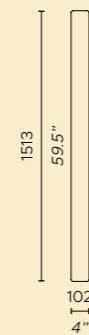

Vela

## Struttura / Frame

-  Antracite  
*Anthracite*
-  Nickel dorato satinato  
*Satin golden nickel*
-  Bronzo-nickel satinato  
*Brushed bronze-nickel*

## Fonte luminosa / Light source

**220 - 240V:**

**Linear I.120** Superiore/upper 1 x 17W Strip LED;  
Inferiore/down 1 x 23W Strip LED; 2700 K; CRI: >90

**Linear I.170** Superiore/upper 1 x 24W Strip LED;  
Inferiore/down 1 x 33W Strip LED; 2700 K; CRI: >90



**Multipla** Superiore/upper 1 x 42W Strip LED;  
Inferiore/down 1 x 90W Strip LED; 2700 K; CRI: >90

**Remote** Fronte/front 1 x 21W Strip LED;  
Retro/back 2 x 14W Strip LED; 2700 K; CRI: >90

**Linear - Multiple - Remote**

Dimmerazione a taglio di fase/Triac - altri sistemi di dimmerazione (DALI e 1-10V) disponibili su richiesta  
*Phase cut/Triac dimming - alternative dimming systems (DALI and 1-10V) available on demand*

## Accessorio vela / Vela accessory

-  Cotone bianco (versione "Remote")  
*White cotton ("Remote version")*
-  Tessuto effetto marmo bianco Calacatta (versione "Remote")  
*White Calacatta marble printed fabric ("Remote version")*

**110V:**

**Linear I.120** Superiore/upper 1 x 17W Strip LED;  
Inferiore/down 1 x 23W Strip LED; 2700 K; CRI: >90

**Linear I.170** Superiore/upper 1 x 24W Strip LED;  
Inferiore/down 1 x 33W Strip LED; 2700 K; CRI: >90

**Multiple** Superiore/upper 1 x 42W Strip LED;  
Inferiore/down 1 x 90W Strip LED; 2700 K; CRI: >90

**Remote** Fronte/front 1 x 21W Strip LED;  
Retro/back 2 x 14W Strip LED; 2700 K; CRI: >90

**Linear - Multiple - Remote**

Dimmerazione a taglio di fase/Triac - sistema di dimmerazione 1-10V disponibile su richiesta  
*Phase cut/Triac dimming - 1-10V dimming system available on demand*

## Lampade da terra / Floor lamps

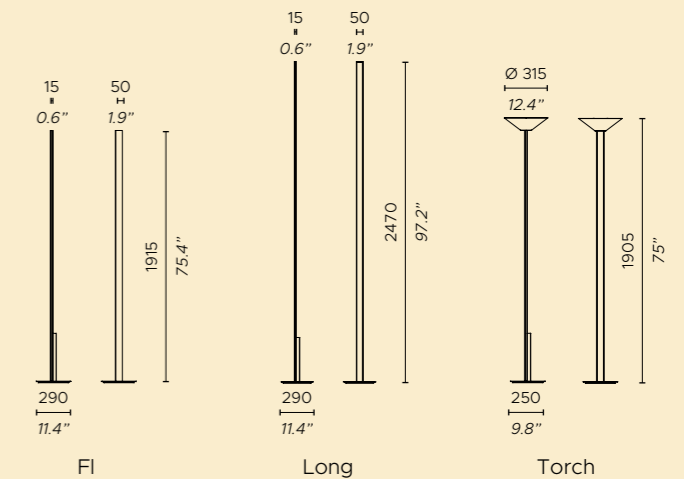
Doppio comando sensoriale lampade da terra  
*Double touch switch floor lamps*

## Struttura / Frame

-  Antracite  
*Anthracite*
-  Nickel dorato satinato  
*Satin golden nickel*
-  Bronzo-nickel satinato  
*Brushed bronze-nickel*

## Fonte luminosa / Light source

**220 - 240V:**

**FI** Fronte/front 1 x 26.5W Strip LED;  
Retro/back 1 x 38W Strip LED; 2700 K; CRI: >90

**Long** Fronte/front 1 x 34.5W Strip LED;  
Retro/back 1 x 49W Strip LED; 2700 K; CRI: >90

**Torch** Superiore/upper 1 x 34.5W Custom LED;  
Retro/back 1 x 49W Strip LED; 2700 K; CRI: >90

**FI - Long**

Dimmerabile fronte e retro, doppio comando sensoriale a bordo  
*Dimmable front and back, double touch switch on board*

**Torch**

Dimmerabile posteriore verticale e superiore, doppio comando sensoriale a bordo  
*Dimmable vertical back and upper, double touch switch on board*

**110V:**

**FI** Fronte/front 1 x 26.5W Strip LED;  
Retro/back 1 x 38W Strip LED; 2700 K; CRI: >90

**Long** Fronte/front 1 x 34.5W Strip LED;  
Retro/back 1 x 49W Strip LED; 2700 K; CRI: >90

**Torch** Superiore/upper 1 x 34.5W Custom LED;  
Retro/back 1 x 49W Strip LED; 2700 K; CRI: >90

**FI - Long**

Dimmerabile fronte e retro, doppio comando sensoriale a bordo  
*Dimmable front and back, double touch switch on board*

**Torch**

Dimmerabile posteriore verticale e superiore, doppio comando sensoriale a bordo  
*Dimmable vertical back and upper, double touch switch on board*



Sospensione / Suspension

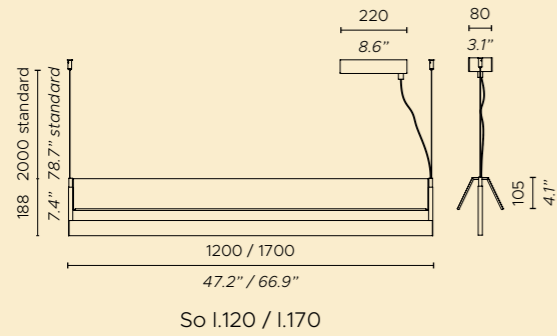

Lampada a parete / Wall light

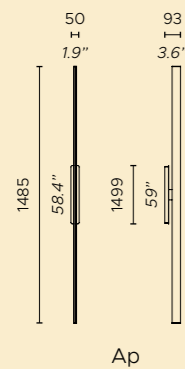

Accessorio Ap / Ap accessory

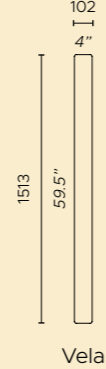

Struttura / Frame



-  Antracite  
Anthracite
-  Nickel dorato satinato  
Satin golden nickel
-  Bronzo-nickel satinato  
Brushed bronze-nickel

Fonte luminosa / Light source

**220 - 240V:**  
**So I.120** Superiore/upper 1 x 17W Strip LED;  
 Inferiore/down 1 x 23W Strip LED; 2700 K; CRI: >90  
**So I.170** Superiore/upper 1 x 24W Strip LED;  
 Inferiore/down 1 x 33W Strip LED; 2700 K; CRI: >90  
**Ap** Fronte/front 1 x 21W Strip LED;  
 Retro/back 2 x 14W Strip LED; 2700 K; CRI: >90

**So - Ap**  
 Dimmerazione a taglio di fase/Triac - altri sistemi di dimmerazione (DALI e 1-10V) disponibili su richiesta  
*Phase cut/Triac dimming - alternative dimming systems (DALI and 1-10V) available on demand*

Accessorio vela / Vela accessory

-  Cotone bianco  
White cotton
-  Tessuto effetto marmo bianco Calacatta  
White Calacatta marble printed fabric

**110V:**  
**So I.120** Superiore/upper 1 x 17W Strip LED;  
 Inferiore/down 1 x 23W Strip LED; 2700 K; CRI: >90  
**So I.170** Superiore/upper 1 x 24W Strip LED;  
 Inferiore/down 1 x 33W Strip LED; 2700 K; CRI: >90  
**Ap** Fronte/front 1 x 21W Strip LED;  
 Retro/back 2 x 14W Strip LED; 2700 K; CRI: >90

**So - Ap**  
 Dimmerazione a taglio di fase/Triac - sistema di dimmerazione 1-10V disponibile su richiesta  
*Phase cut/Triac dimming - 1-10V dimming system available on demand*

Lampade a parete / Wall lights

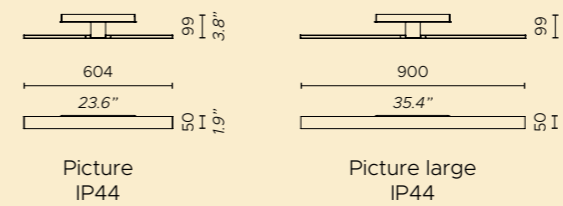

Struttura / Frame

-  Antracite  
Anthracite
-  Nickel dorato satinato  
Satin golden nickel
-  Bronzo-nickel satinato  
Brushed bronze-nickel
-  Rame satinato  
Satin copper

Fonte luminosa / Light source

**220 - 240V:**  
**Picture** 1 x 11.5W Strip LED; 2700 K; CRI: >90; IP44  
**Picture large** 1 x 17.5W Strip LED; 2700 K; CRI: >90; IP44

**Picture - Picture large**  
 Dimmerazione a taglio di fase/Triac - altri sistemi di dimmerazione (DALI e 1-10V) disponibili su richiesta  
*Phase cut/Triac dimming - alternative dimming systems (DALI and 1-10V) available on demand*

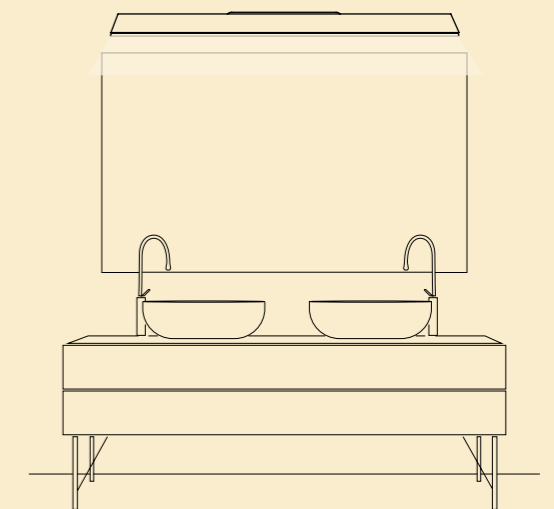

Esempio applicazione Fly picture large  
 Application example Fly picture large

**110V:**  
**Picture** 1 x 11.5W Strip LED; 2700 K; CRI: >90; IP44  
**Picture large** 1 x 17.5W Strip LED; 2700 K; CRI: >90; IP44

**Picture - Picture large**  
 Dimmerazione a taglio di fase/Triac - sistema di dimmerazione 1-10V disponibile su richiesta  
*Phase cut/Triac dimming - 1-10V dimming system available on demand*





KIKI  
CONTARDI STUDIO





“Con **Kiki** abbiamo espresso il desiderio di essere in collezione anche noi, a fianco dei grandi designer, con un prodotto sviluppato internamente, che rispondesse alle richieste del mercato e che esprimesse il nostro concetto di lampade. Oggetti funzionali, decorativi, strumenti di progettazione al servizio dei più creativi architetti e interior designer.”

*“With **Kiki** we have expressed the desire to be in the collection ourselves, side by side with great designers, with a product developed in-house that would respond to the requirements of the market while expressing our concept of lamps. Functional decorative objects, tools at the service of the most creative architects and interior designers.”*





Sospensioni / Suspensions

Kiki è un prodotto modulare disponibile nelle versioni sospensione, a parete e da tavolo. Il cavo in tessuto, tono su tono o in contrasto con la struttura, consente di creare sistemi e disegni su pareti. Con la versione a sospensione è possibile realizzare scenografici cluster.

*Kiki is a modular product available in suspension, wall and table versions. The tone-on-tone fabric cable, or to its contrast with the structure, this product allows creative compositions on walls. With the pendant version it is possible to create scenographic clusters.*





Lampada a parete  
Wall light



Lampade a parete  
Wall lights





Sistema modulare "Kiki connect"  
"Kiki connect" modular system



ESEMPI COMPOSIZIONI **KIKI CONNECT**  
**KIKI CONNECT** COMPOSITION EXAMPLES



A. Composizione lineare / *Linear composition*

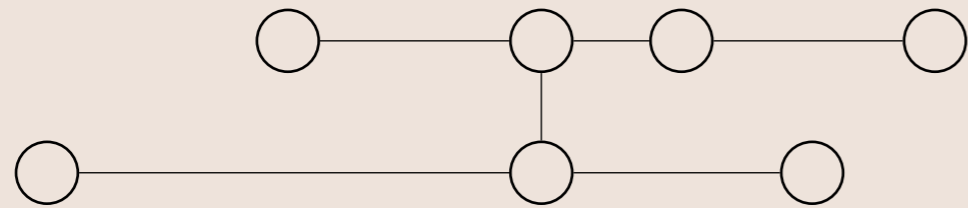

B. Composizione lineare multipla / *Multiple linear composition*

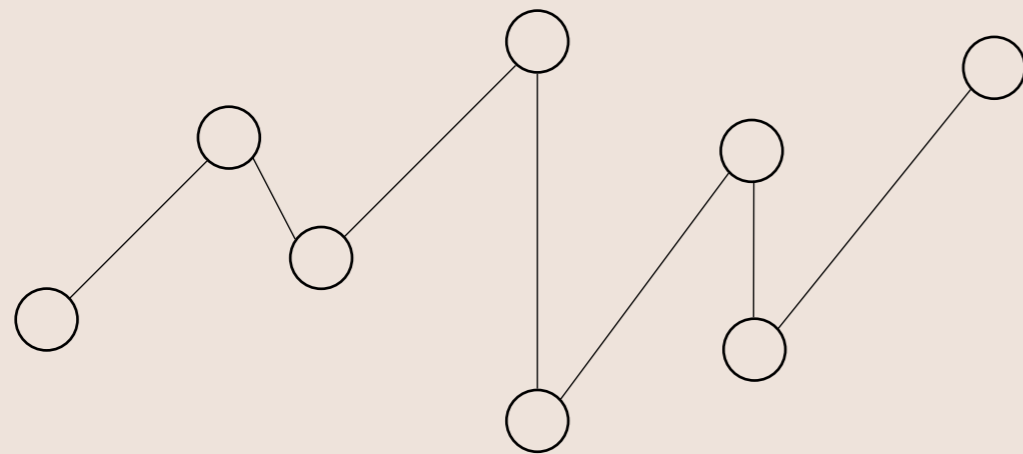

C. Composizione irregolare / *Irregular composition*

Driver a bordo compatibile con taglio di fase/Triac - Possibilità di composizioni potenzialmente infinite da una sola uscita elettrica. Uscita dei cavi ogni 45°.  
 Possibilità di collegamento alla presa di corrente con spina e comando tramite interruttore.

*Driver on board compatible with phase cut/Triac - Possibility of creating infinite compositions from a single electrical output. Cable outlet at 45°.  
 Possibility of connection to the socket with plug and switch control.*



Sistema modulare "**Kiki connect**"  
 "**Kiki connect**" modular system





Sistema modulare "Kiki connect" con spina  
"Kiki connect" modular system with plug





Lampada da tavolo  
Table lamp

### Lampade a parete / Wall lights

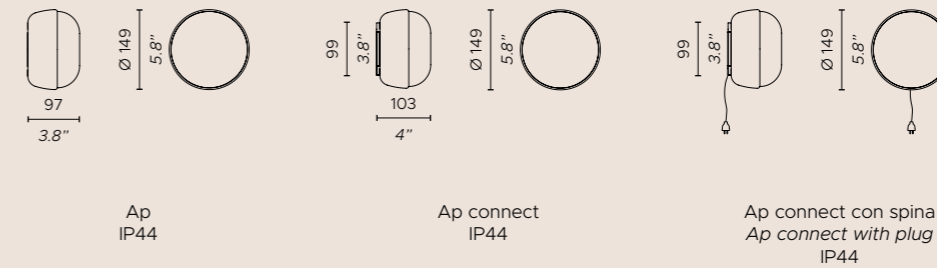

### Lampada da tavolo Table lamp

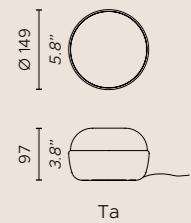

### Sospensioni / Suspensions

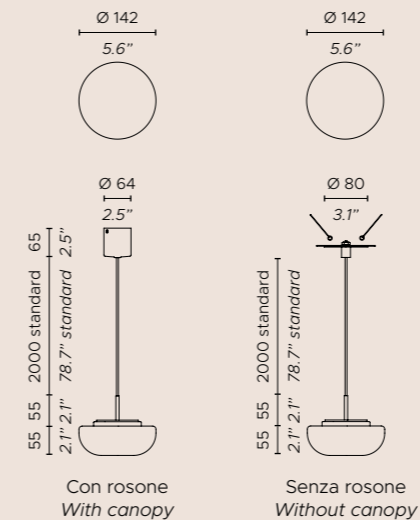

### Cluster rotondi / Round clusters

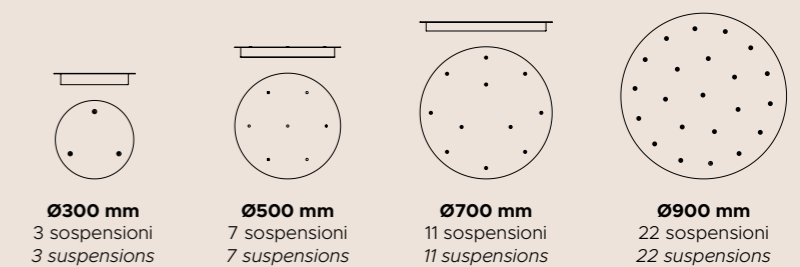

### Cluster lineari / Linear clusters

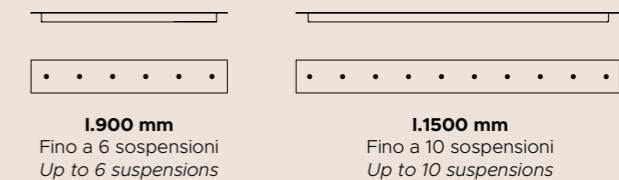

### Accessorio So - Ap connect / So - Ap connect accessory

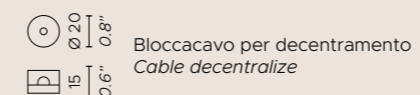

### Struttura / Frame

- Antracite  
Anthracite
- Nickel dorato satinato  
Satin golden nickel
- Bronzo-nickel satinato  
Brushed bronze-nickel
- Laccato bianco opaco  
Matt white lacquered  
(Ap - Ap connect)

### Fonte luminosa / Light source

**220 - 240V:**  
Ap - So - Ta 1 x 5W Custom LED; 550 Lm; 2700 K;  
CRI: >90

**Ap - So**  
Dimmerazione a taglio di fase/Triac - altri sistemi di dimmerazione (DALI e 1-10V) disponibili su richiesta  
Phase cut/Triac dimming - alternative dimming systems (DALI and 1-10V) available on demand

**Ta**  
Dimmerabile, interruttore push sulla base  
Dimmable, push switch on the base

### Diffusore / Diffuser

- Vetro bianco opale  
Satin opal glass

### Accessori Ap connect / Ap connect accessories

- Cavo in tessuto color arancio  
Orange colour fabric cable
- Cavo in tessuto color sabbia  
Sand colour fabric cable
- Cavo in tessuto color nero  
Black colour fabric cable

**110V:**  
Ap - So - Ta 1 x 5W Custom LED; 550 Lm; 2700 K;  
CRI: >90

**Ap - So**  
Dimmerazione a taglio di fase/Triac - sistema di dimmerazione 1-10V disponibile su richiesta  
Phase cut/Triac dimming - 1-10V dimming system available on demand

**Ta**  
Dimmerabile, interruttore push sulla base  
Dimmable, push switch on the base





STICK  
STUDIOPEPE







“La purezza che volevamo ottenere con **Stick** è stata raggiunta grazie alla collaborazione con i tecnici della luce di Contardi. Progettare e disegnare ogni minimo dettaglio costruttivo insieme al loro team ha permesso di ottenere un prisma di pulizia estrema, esteriormente semplice ed essenziale, contenitore di una tecnologia articolata.”

*“The purity we wanted to achieve with **Stick** has been reached thanks to collaboration with the light technicians of Contardi. To design every constructive detail, down to the smallest, together with their theme has permitted us to obtain a prism of extreme refinement, simple and essential on the outside, but containing complex technology.”*





Lampade da terra  
*Floor lamps*

In Stick la luce si propaga, sapientemente modulata, attraverso un diffusore con effetto vetro cannettato, contenuto all'interno di un estruso metallico nelle finiture satinato rame e nickel dorato.

*In Stick the light emanates, skillfully modulated, through a diffuser with a ribbed glass effect, contained within a metal extrusion in satin copper and gold nickel finishes.*



Lampada da terra  
*Floor lamp*





Lampade a parete  
Wall lights

### Lampada da terra / Floor lamp



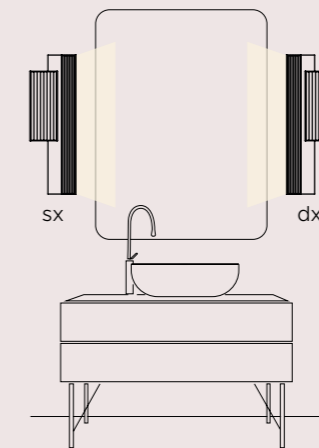
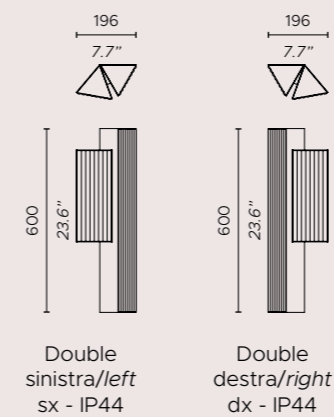

### Lampade a parete / Wall lights



Esempio applicazione  
ap double destra e sinistra  
Application example  
ap double right and left

### Struttura / Frame

-  Nickel dorato satinato  
Satin golden nickel
-  Rame satinato  
Satin copper

### Diffusore / Diffuser

-  Plexiglass rigato  
Striped plexiglass

### Fonte luminosa - Light source

#### 220 - 240V:

**Ap double sinistra e destra / left and right**  
1 x 13.5W Custom LED + 1 x 27W Custom LED;  
3750 Lm; 2700 K; CRI: >90; IP44

**FI** 5 x 13.5W Custom LED; 7500 Lm; 2700 K; CRI: >90

#### Ap double sinistra e destra / left and right

Dimmerazione a taglio di fase/Triac - altri sistemi di dimmerazione (DALI e 1-10V) disponibili su richiesta  
Phase cut/Triac dimming - alternative dimming systems (DALI and 1-10V) available on demand

#### FI

Dimmerabile a piede / Foot dimmable

#### 110V:

**Ap double sinistra e destra / left and right**  
1 x 13.5W Custom LED + 1 x 27W Custom LED;  
3750 Lm; 2700 K; CRI: >90; IP44

**FI** 5 x 13.5W Custom LED; 7500 Lm; 2700 K; CRI: >90

#### Ap double sinistra e destra / left and right

Dimmerazione a taglio di fase/Triac - sistema di dimmerazione 1-10V disponibile su richiesta  
Phase cut/Triac dimming - 1-10V dimming system available on demand

#### FI

Dimmerabile a piede / Foot dimmable



## Sospensioni / Suspensions

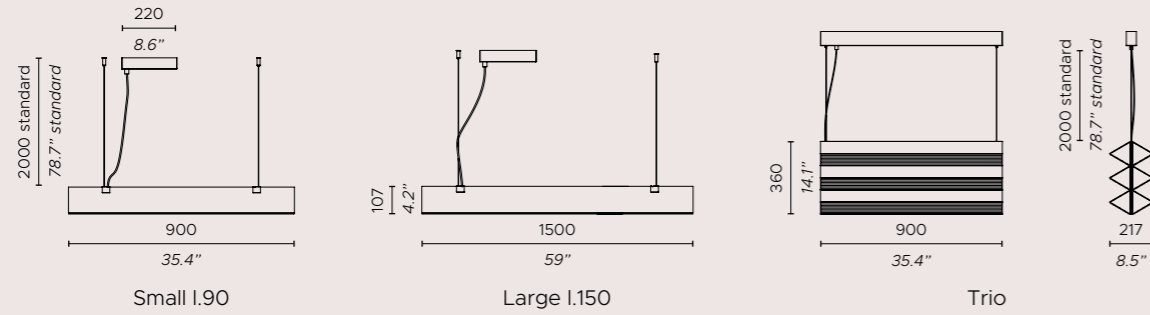

## Lampade a parete / Wall lights

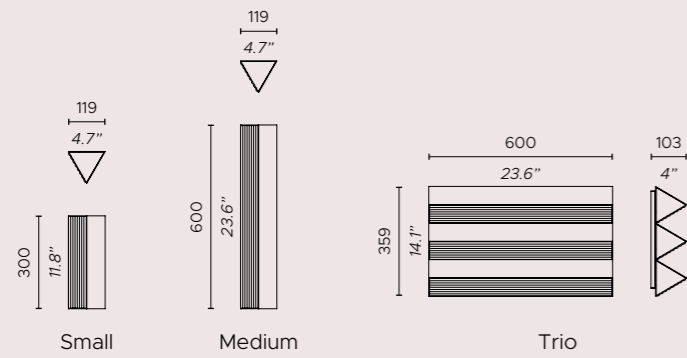

## Fonte luminosa - Light source

**220 - 240V:**

**So small I.90** 1 x 40W Custom LED; 3750 Lm; 2700 K; CRI: >90

**So large I.150** 1 x 65W Custom LED; 6250 Lm; 2700 K; CRI: >90

**So trio** 6 x 40W Custom LED; 22500 Lm; 2700 K; CRI: >90

**Ap small** 1 x 13.5W Custom LED; 1250 Lm; 2700 K; CRI: >90

**Ap medium** 1 x 27W Custom LED; 2500 Lm; 2700 K; CRI: >90

**Ap trio** 3 x 27W Custom LED; 7500 Lm; 2700 K; CRI: >90

Dimmerazione a taglio di fase/Triac - altri sistemi di dimmerazione (DALI e 1-10V) disponibili su richiesta  
Phase cut/Triac dimming - alternative dimming systems (DALI and 1-10V) available on demand

**110V:**

**So small I.90** 1 x 40W Custom LED; 3750 Lm; 2700 K; CRI: >90

**So large I.150** 1 x 65W Custom LED; 6250 Lm; 2700 K; CRI: >90

**So trio** 6 x 40W Custom LED; 22500 Lm; 2700 K; CRI: >90

**Ap small** 1 x 13.5W Custom LED; 1250 Lm; 2700 K; CRI: >90

**Ap medium** 1 x 27W Custom LED; 2500 Lm; 2700 K; CRI: >90

**Ap trio** 3 x 27W Custom LED; 7500 Lm; 2700 K; CRI: >90

Dimmerazione a taglio di fase/Triac - sistema di dimmerazione 1-10V disponibile su richiesta  
Phase cut/Triac dimming - 1-10V dimming system available on demand







OUTDOOR  
COLLECTION  
IP65





# MATERIALS AND COLOURS

## *OUTDOOR COLLECTION*

### *Struttura / Frame*



Laccato bronzo  
*Bronze lacquered*



Laccato nero  
*Black lacquered*

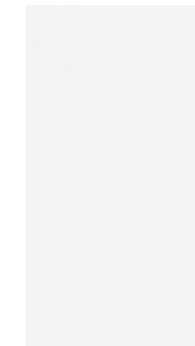

Laccato bianco  
opaco / *Matt  
white lacquered*

### *Diffusore / Diffuser*



Resina effetto  
paglia di Vienna  
*Vienna straw  
resin effect*



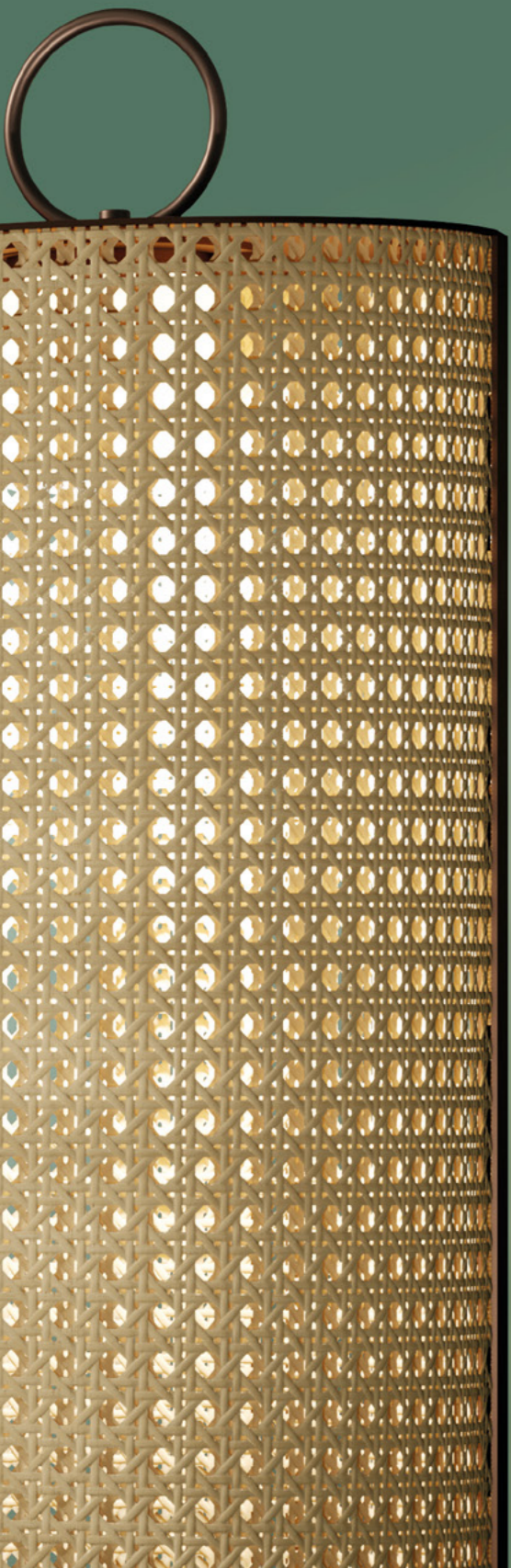

# CLARA

CHIARA CABERLON

in collaborazione con Marco Forbicioni  
*in collaboration with Marco Forbicioni*

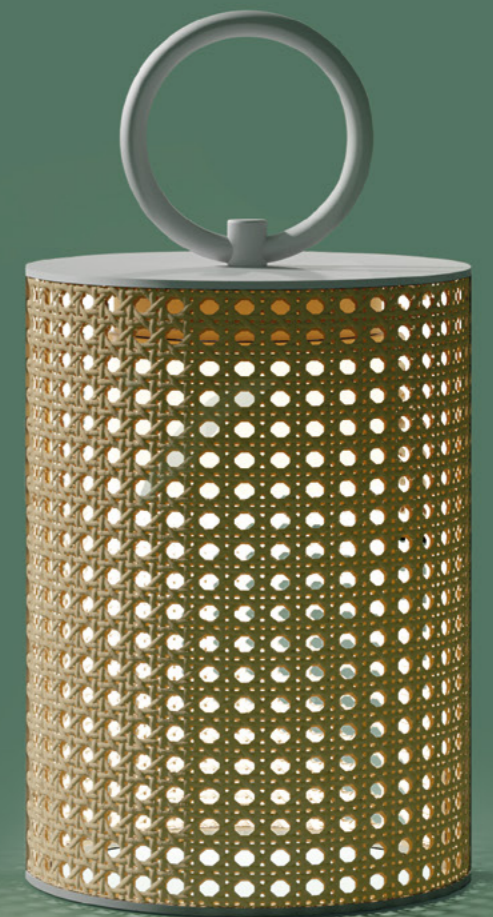





“La collezione di lampade **Clara** è nata per rispondere a una richiesta di Contardi di dare vita a una collezione outdoor IP65 destinata al mercato contract. Ne è uscita una lanterna trasportabile dall’anima nomade, che grazie all’incredibile expertise dell’azienda nella scelta e lavorazione dei materiali, sprigiona una magica luce calda e suggestiva.”

*“The **Clara** collection of lamps has been created to respond to a request on the part of Contardi to formulate an outdoor collection IP65 for the contract market. The result is a portable lantern with a nomadic spirit, which thanks to the company’s incredible expertise and approach to materials broadcasts magical, warm and evocative light.”*

**Chiara Caberlon**

in collaborazione con  
in collaboration with  
**Marco Forbicioni**





Versione "small" a batteria  
 "Small" battery-powered version

Clara nasce dal concetto di "portare luce". Un elemento luminoso facilmente trasportabile ovunque, grazie alla scelta dell'alimentazione a batteria ricaricabile e alla presenza di un anello allocato nella parte superiore che funge da gancio per appenderla o spostarla.

*Clara comes from the concept of "bringing light". A light element easily transportable anywhere, thanks to the choice of the rechargeable battery power supply and the presence of a ring allocated at the top that serves as a hook to hang or move it.*



Lampade a batteria  
 Battery-powered lamps





Lampade a batteria  
Battery-powered lamps





Fonte luminosa estraibile, trasportabile, a batteria ricaricabile  
Removable, transportable, rechargeable light source

### Lampade a batteria / Battery-powered lamps

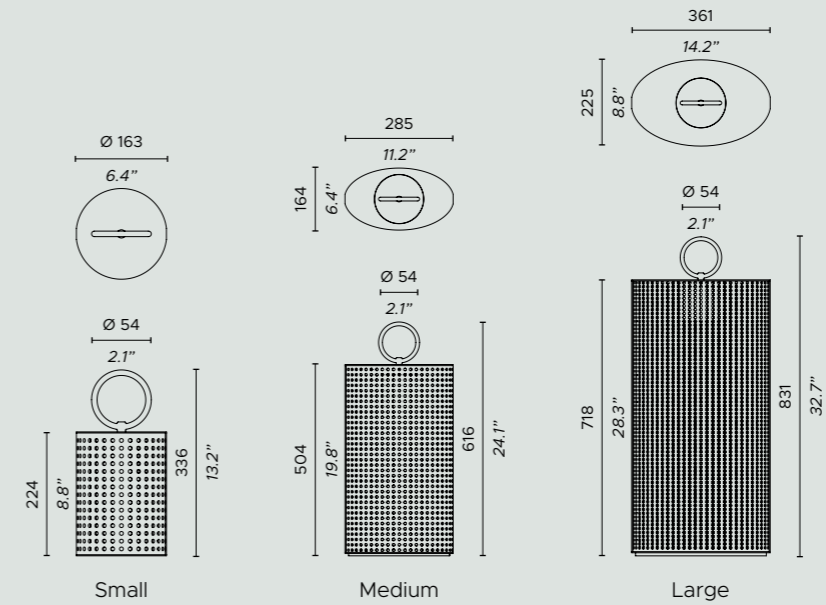

### TRASPORTABILITÀ TRANSPORTABILITY



### ACCENSIONE / SPEGNIMENTO ON / OFF SWITCHING

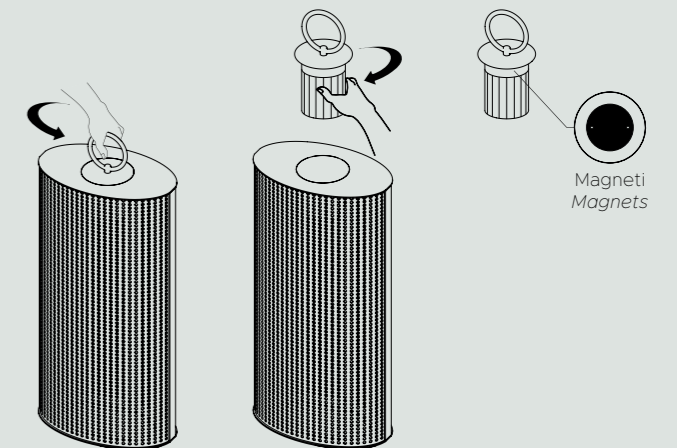

### Struttura / Frame

 Laccato bianco opaco  
Matt white lacquered

 Laccato bronzo  
Bronze lacquered

### Diffusore / Diffuser

 Resina effetto paglia di Vienna  
Vienna straw resin effect

### Fonte luminosa - Light source

Battery 1 x 4W LED module; 400 Lm;  
2700 K; CRI: >90

IP65



FLY  
OUTDOOR  
MASSIMILIANO RAGGI

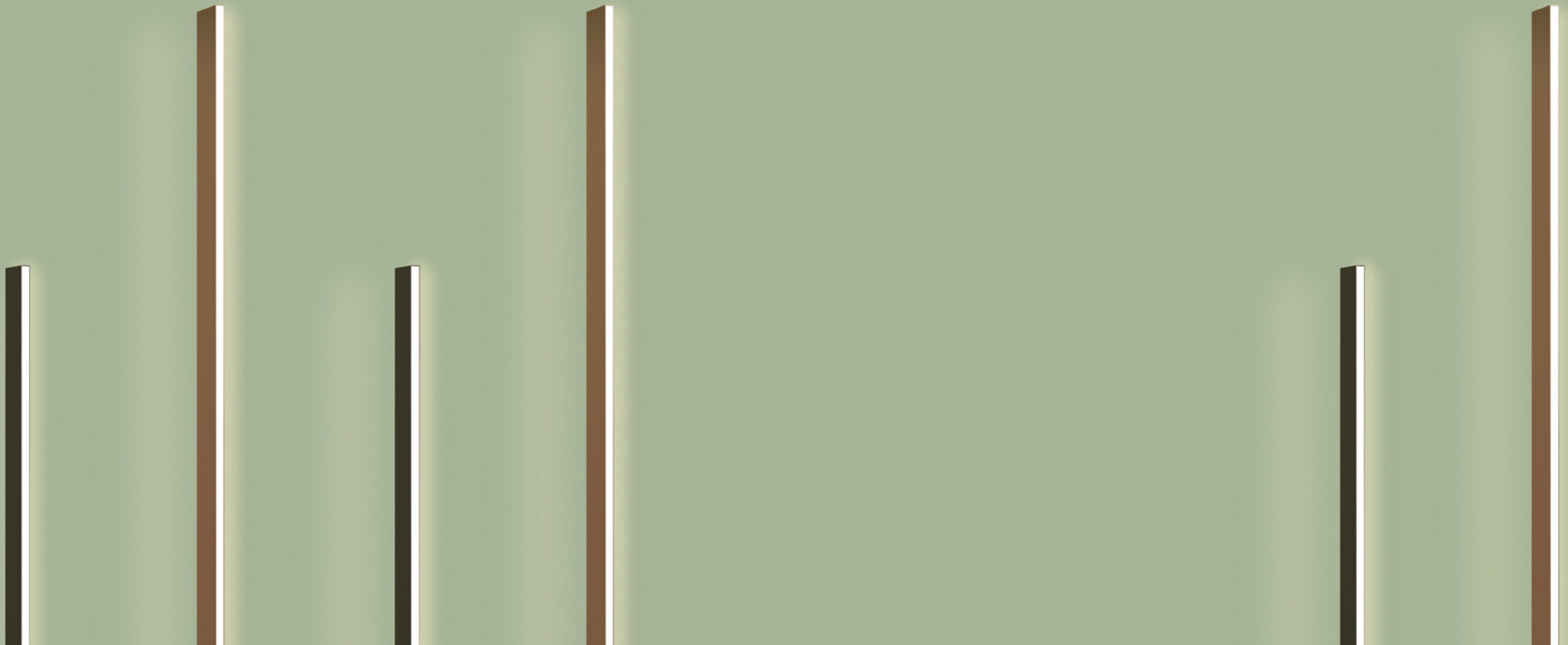





Lampade outdoor da terra  
Outdoor floor lamps





Lampade outdoor da terra  
Outdoor floor lamps

Lampade da terra / Floor lamps

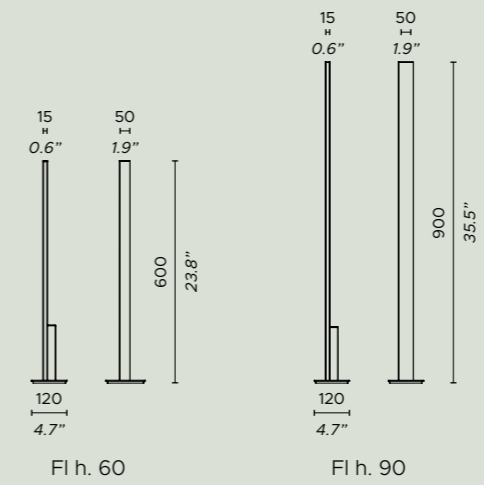

Struttura / Frame

- Laccato nero  
Black lacquered
- Laccato bronzo  
Bronze lacquered

Fonte luminosa - Light source

- FI h.60 1 x 8W Custom LED; 2700 K
- FI h.90 1 x 12.5W Custom LED; 2700 K

IP65



## THANKS TO

**Graphic Project:**

Claudia Parisi

**Mise en page:**

Martina Castiglieri

**Photos:**

Marco Reggi

**Render:**

Arché Agency  
Officine Mimesi  
Dainelli Studio

**Print:**

Grafiche Antiga, Crocetta del Montello (TV)

@Contardi Lighting srl  
07.2023

**CONTARDI LIGHTING SRL**

*Italy Headquarters*  
Via A. Manzoni, 134/140  
20811 Cesano Maderno (MB)

**CONTARDI MILANO**

*Showroom*  
Corso Monforte, 20  
20122 Milano (MI)

**CONTARDI USA Inc**

*USA Branch*  
151 Wooster St - Floor 2  
10012 New York - NY



**CONTARDI LIGHTING Srl**  
*Italy Headquarters*

Via A. Manzoni, 134/140  
20811 Cesano Maderno (MB)  
Phone: +39 0362 301381  
Mail: [sales@contardi-italia.it](mailto:sales@contardi-italia.it)  
[contardi-italia.com](http://contardi-italia.com)

---

**CONTARDI MILANO**  
*Showroom*

Corso Monforte, 20  
20122 Milano (MI)  
Phone: +39 02 82 76 5952  
Mail: [milano@contardi-italia.it](mailto:milano@contardi-italia.it)  
[contardi-italia.it/showroom](http://contardi-italia.it/showroom)

---

**CONTARDI USA Inc**  
*USA Branch*

151 Wooster St - Floor 2  
10012 New York - NY  
Phone: +1 718 715 0717  
Mail: [office@contardi-usa.com](mailto:office@contardi-usa.com)  
[contardi-usa.com](http://contardi-usa.com)

@Contardi Lighting srl  
07.2023

Follow **Contardi Lighting** on:

