

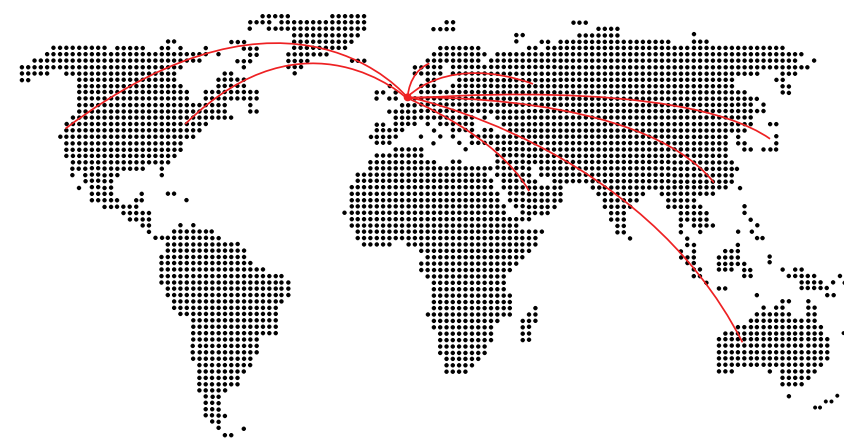



Office Eden Design, Genk, Belgium



Handmade in Belgium

Since 2007 we combine the imagination of the designers with our research and development, allowing in only a few years to create a range of products with timeless design, distributed from Genk, Belgium to over 50 countries world-wide.

Innovation & Quality

Artificial light is as important as sunlight, which is why Eden Design invests all its knowhow in exclusive and innovative lighting products that comply with international quality standards.

Personal project

Most of the lighting products can be customized, allowing to obtain an exclusive product that is adapted to your projects. You will thus be able to create an atmosphere, accentuate objects (clothes, paintings, ...) as you wish.

| | | |
|-----|----------------------|-----|
| | °online | 8 |
| | °knick | |
| | °knick small | |
| | °in | |
| | °in small | |
| | °turn | |
| NEW | °turn plus | |
| NEW | °turn soraa | |
| | °out | |
| NEW | °udisk | |
| NEW | °odisk | |
| | °dot | |
| NEW | °dot turn | |
| NEW | °bloc | 78 |
| NEW | °hide-out | 90 |
| | °led line | 100 |
| NEW | °oh!led | 108 |
| | °sphere | 116 |
| | °led on fire | 134 |
| | °fool moon | 140 |
| NEW | °leditbi | 156 |
| | °XXXL(amp) | 164 |
| | °diabolo | 174 |
| | °XL(amp) | 180 |
| | °i-light | 192 |
| | °table cloth | 198 |
| | °SO1 | 204 |
| | °poirot | 210 |
| | °de light ful | 218 |

°online

The power of this light source lies in its slenderness and unobtrusiveness; the simplicity of the fixtures' design makes that it can be used anywhere. An innovative and state-of-the-art magnet and contact system makes that a wide variety of led-fixtures can be easily inserted or moved.

The led-fixtures are similar in style yet each one of them has its own character and lighting quality.

Eden Design was the first to introduce this magnet system on the market. First presentation was in **2010** on the designfair Interieur Kortrijk, Belgium.

This collection won several awards, such as:

- The Best of the Best Red Dot Award (2011)
- Design Plus powered by Light & Building (2012)
- Henri van de Velde Label (2010)

Design by Bart Lens



reddot design award
best of the best 2011



DESIGN PLUS
powered by: light+building



°turn

°in.small

°dot

°knick.small

°knick

°out

°in

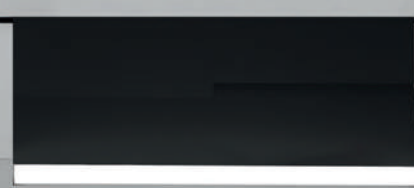
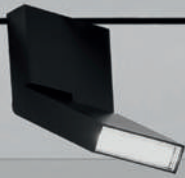



*online / Grey Office, Greece - architects eDje - photograph by Vangelis Paterakis

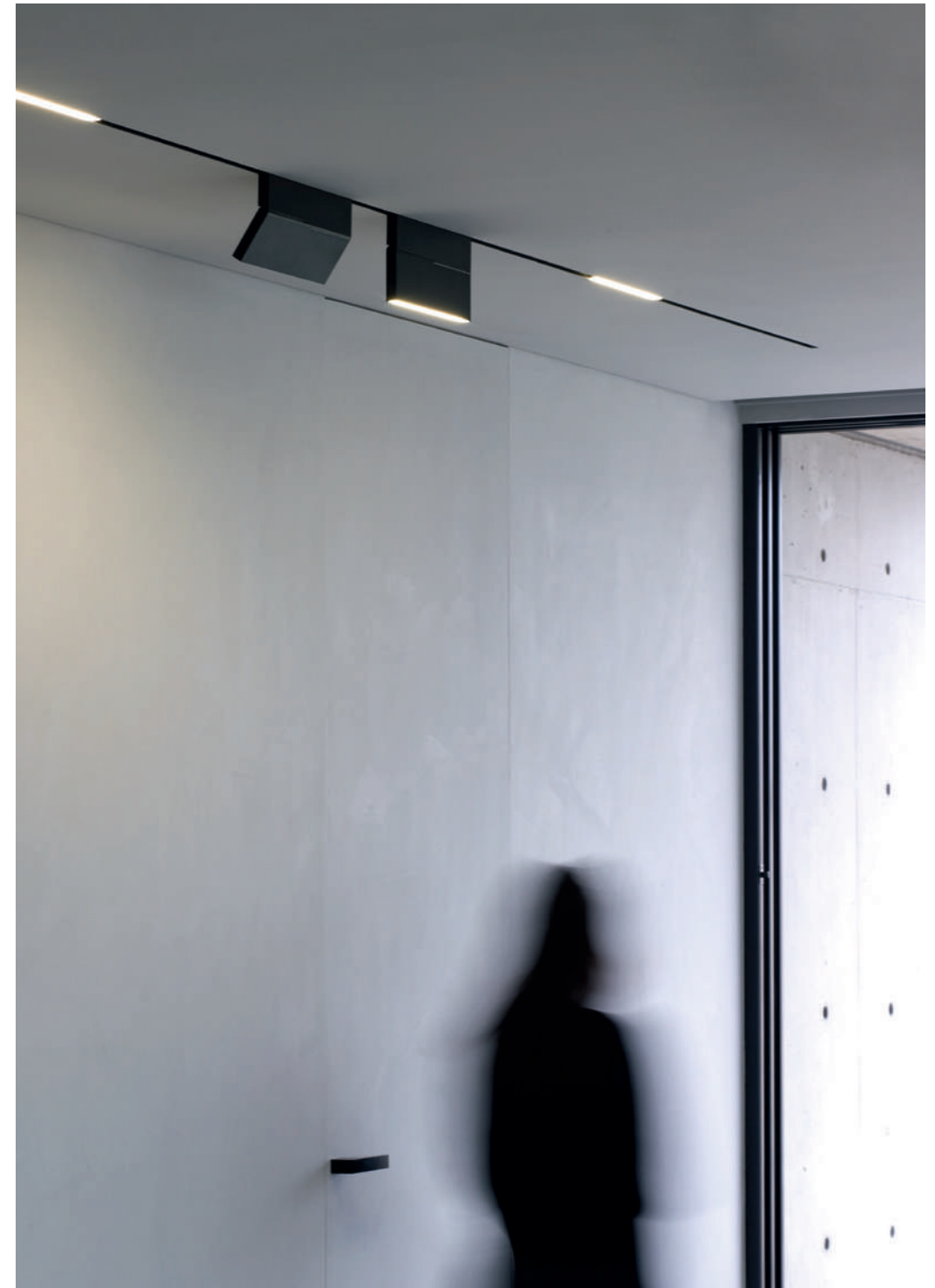

*online / Grey Office, Greece- architects eDje - photograph by Vangelis Paterakis



NEW

°o-disk / general lighting



NEW

°u-disk / powerful spot



*knick / Harbour Green, Hong Kong - architect Millimeter Interior Design Limited



*turn / apartment, Israel - architect Pitsuo Kedem - ST-OR - lighting design Orly Avron - photograph by Amit Geron



°online / Villa V, Belgium - architect Francisca Hautekeete - photograph by Annick Vernimmen

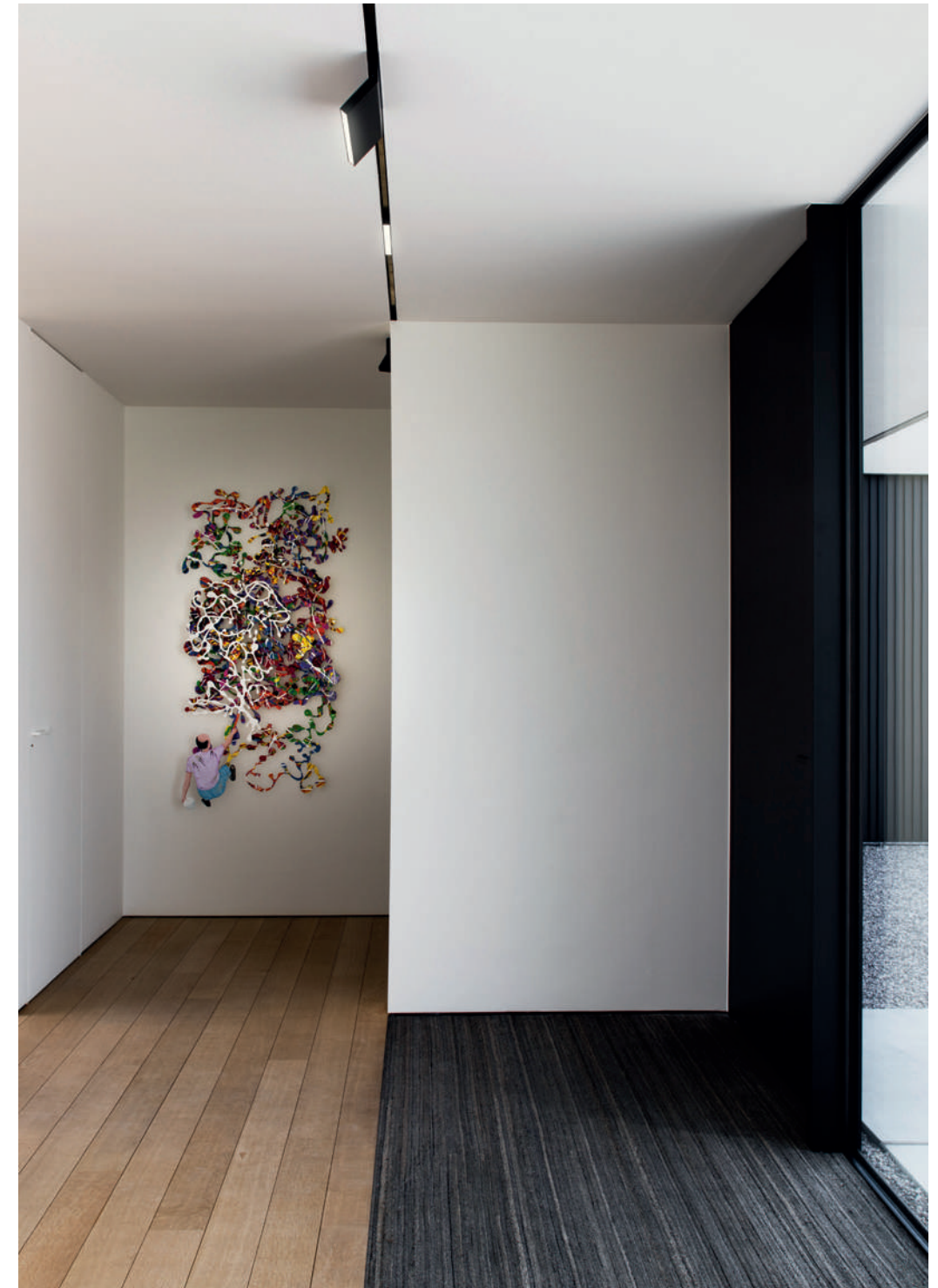

°online / Villa V, Belgium - architect Francisca Hautekeete - photograph by Annick Vernimmen



*knick / Apartment, Paris - architect Angelo View Drive



*turn / Villa, Belgium - architect Pascal François - photograph by Thomas De Bruyne (cafeine.be)



*knick.small & *knick





*knick / Penthouse, Ukraine - architect NOTT Design Studio (Sergey Gotvyansky, Mikhail Temnikov)



°out monopoint with plasterkit / Beach house Knokke - architect Glenn Reynaert - photograph by Hendrik Biegs



*in monpoint with plasterkit



*knick monpoint with plasterkit



° knick



°dot monopoint with plasterkit



°dot monopoint with plasterkit / Grey Perfection, Moscow - architect Dina Mezheva - photograph by Bogdan Vitkov

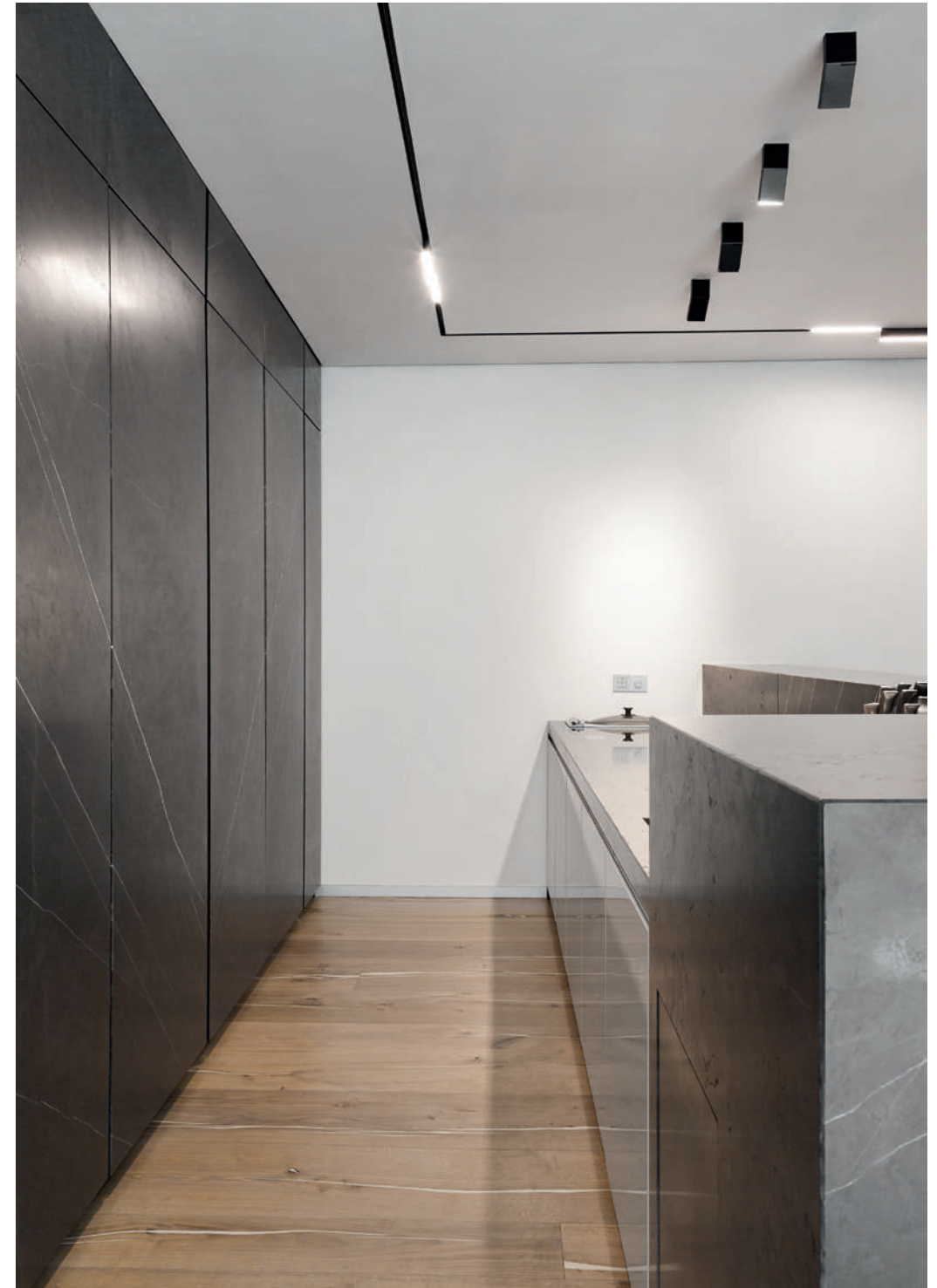

°turn monopoint with plasterkit & °knick / Grey Perfection, Moscow - architect Dina Mezheva - photograph by Bogdan Vitkov



*turn / galerie Kamel Mennour, Paris - architect Pierre Yovanovitch - lighting design Dominique Liners (ETOILES)
 photograph by Jean-François Jaussaud - Luxproductions



*turn / galerie Kamel Mennour, Paris - architect Pierre Yovanovitch - lighting design Dominique Liners (ETOILES)
 photograph by Jean-François Jaussaud - Luxproductions





*knick / Industrial loft, Russia - architect Denis Krasikov, Cartelle Design

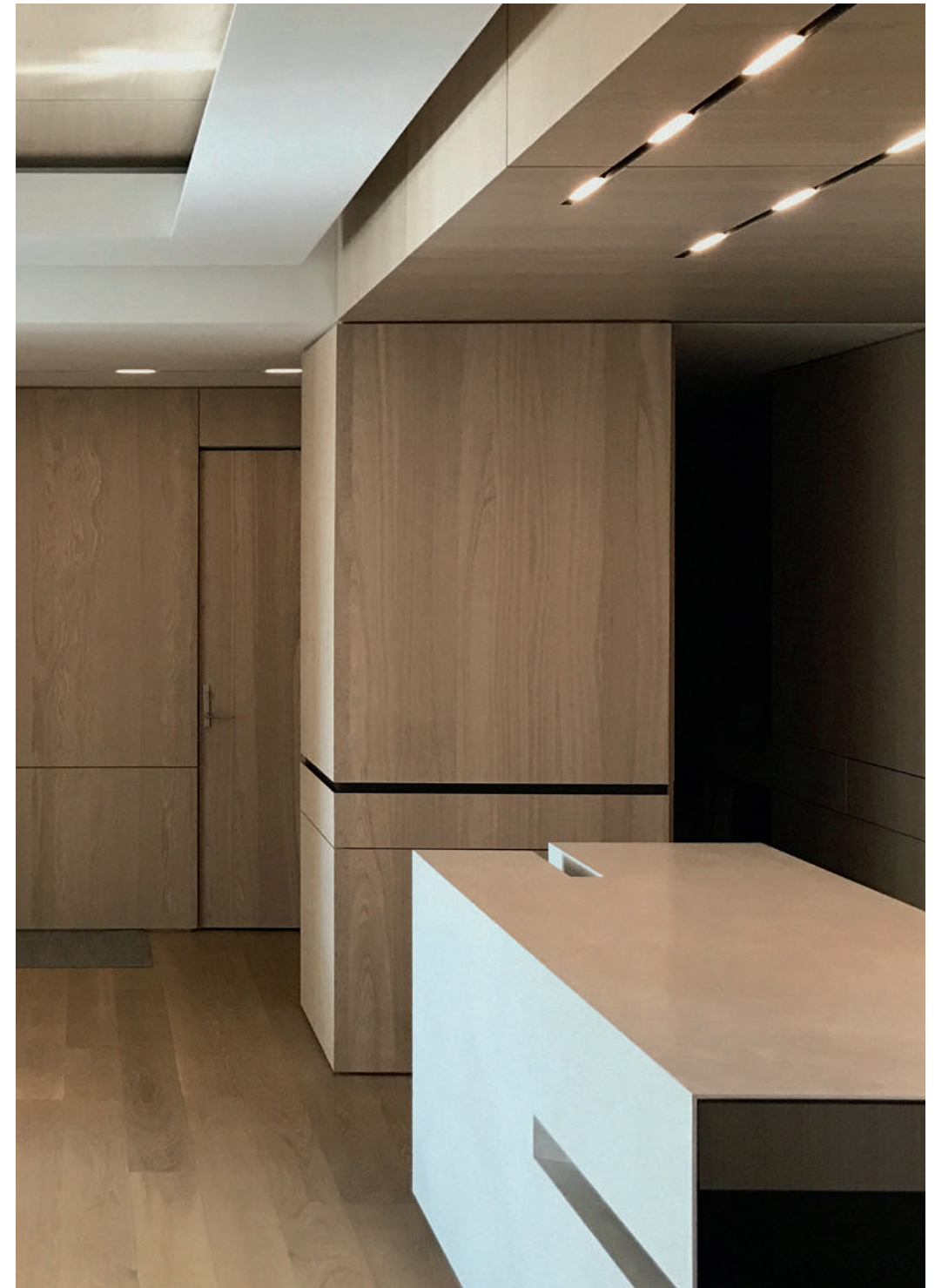

*in / Regency NY - architect Workshop APD - custom building contractor Dutchman Contracting, Inc.



°out / Church Genk, Belgium - architect PCP Architects - photograph by Philippe van Gelooven



°online suspended track / Design Museum Gent, Belgium - photograph by Beeldpunt





*knick / Men's Choice II, Slovakia - architects AT26 - photograph by Jakub Dvorak



*knick / Grosvenor House Coconut Grove, Miami - RS3 Design - Luxe Cable + Light



°online surface mounted / House, Belgium - architect Project B



°out / office, Australia

line

material aluminium coated
 weight 1,75 kg/lm - 1,16 lb/feet
 voltage 24Vdc
 max wattage 240W on single circuit
 circuits 2
 dimming 1-10V / 0-10V / Dali
 certifications CE  
 classifications IP20 

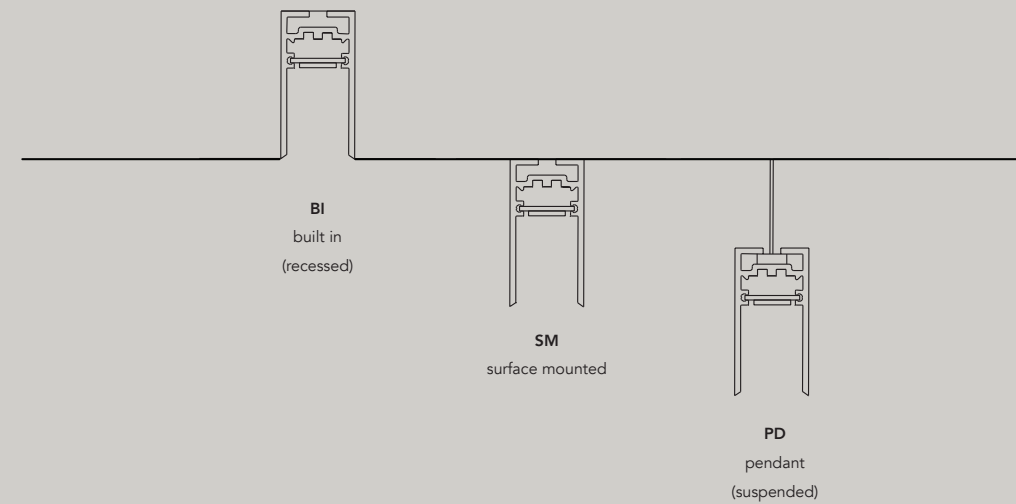
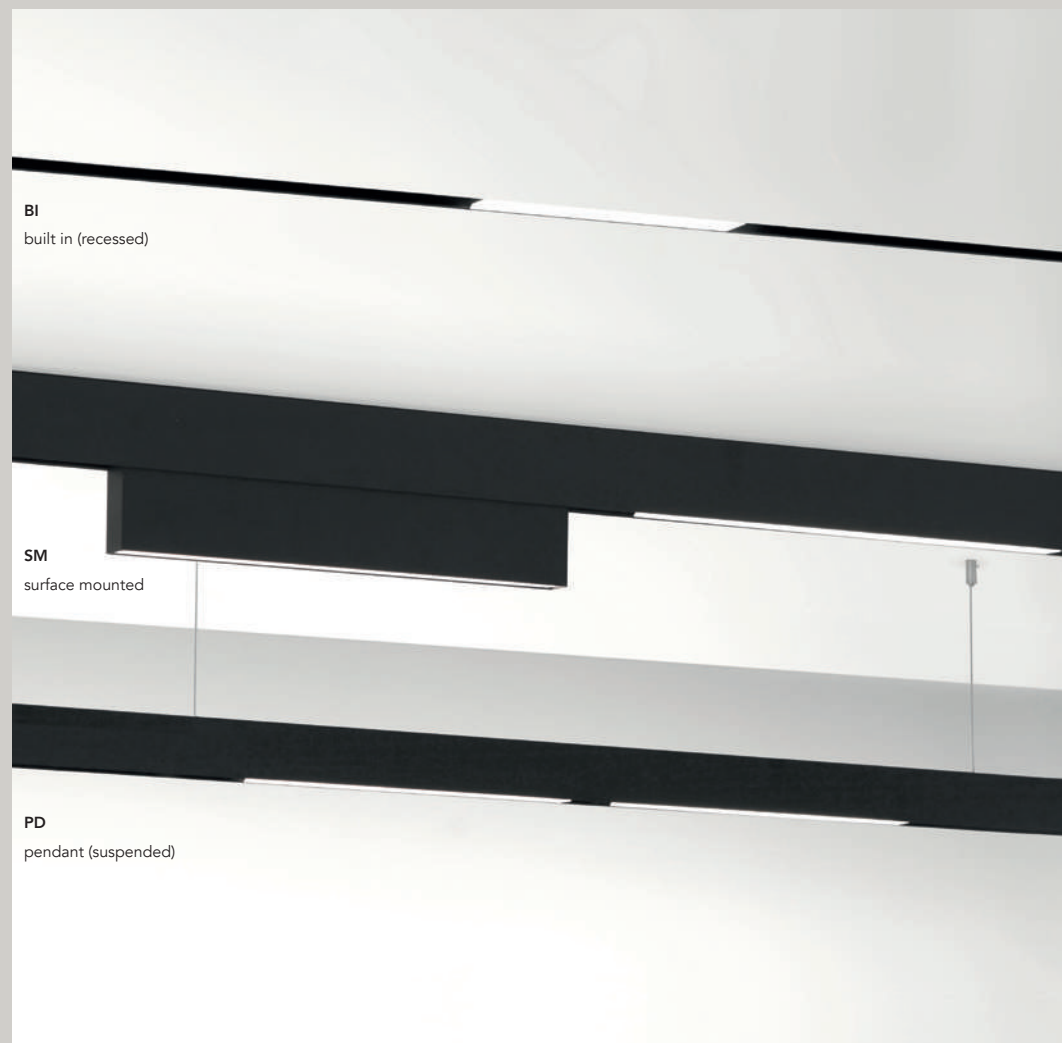
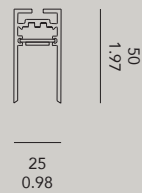

L.L.C.T

| | | |
|---------------|-------------------------------------|---|
| Length | 4000 300 - ... | standard length in mm custom length in mm |
| Color body | BK WH AL | black matt ral 9011 white matt ral 9016 aluminium color ral 9006 (on request only) |
| Type mounting | BI SM PD | built in (recessed) surface mount pendant (suspended / standard cable of 2m included) |

Brackets

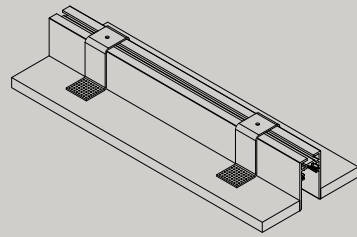
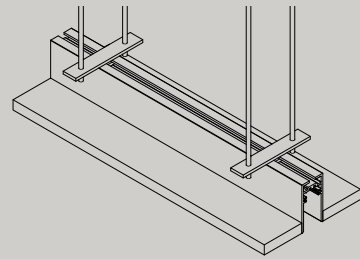
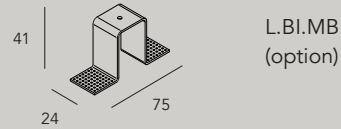
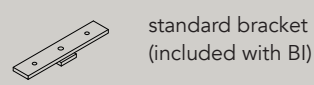

Connectors

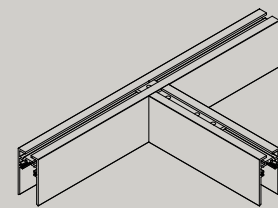
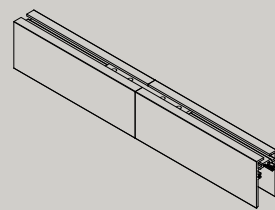
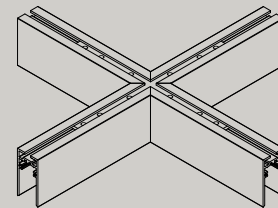
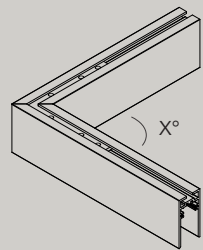
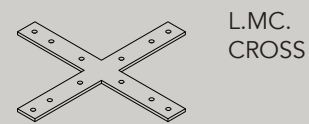
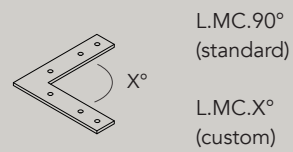

Round Corner

End Cap

Pendant Extension Cable

L.CORN.RND.WH
L.CORN.RND.BK

L.EC.WH
L.EC.BK
L.EC.AL

PD.EC.8M

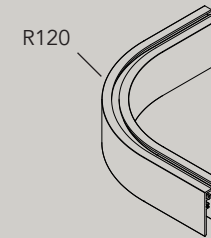

L.CP.L.C

Cover profile

| | | |
|--------|---|---|
| Length | 1000 2000 4000 | 1000 mm - 39,37 in 2000 mm - 78,74 in 4000 mm - 157,48 in |
|--------|---|---|

| | | |
|-------|-------------------------------------|---|
| Color | BK WH AL | black matt ral 9011 white matt ral 9016 aluminium color ral 9006 (on request only) |
|-------|-------------------------------------|---|

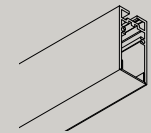

power supply ceiling box (only for surface mounted version)

| | |
|---------|-------------|
| PSCB.BK | color black |
| PSCB.WH | color white |

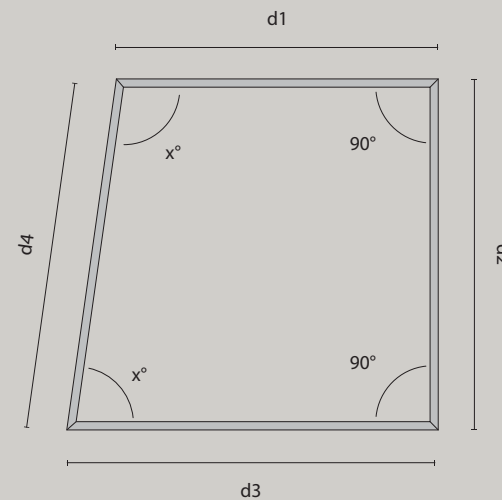

Mention the outside dimensions of the tracks and the inner corners

°knick

material aluminium coated
 weight 990gr / 2.18lb
 voltage 24Vdc
 cri >90
 wattage 16,5W
 dali supported (option)
 DALI DT8, tunable white
 inclination 90°
 certifications CE, ENEC
 classifications IP20

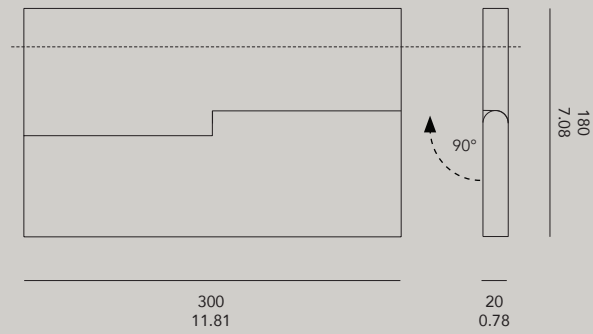

KNICK.L.C.D.V.D

| | | | |
|-------------|---|---|--|
| Led | WW WW2 NW2 TW | 2700K 16,5W 3000K 16,5W 4000K 16,5W tunable white (only with IC) 18W 2200-6500°K | |
| Color body | BK WH AL | black matt ral 9011 white matt ral 9016 aluminium color ral 9006 (on request only) | |
| Diffuser | FI MP | frosted ice diffuser (wide beam) microprism diffuser (wide beam & anti-glare) | WW 1100 lm / 490 cd WW2 1100 lm / 490 cd NW2 1100 lm / 490 cd TW WW 1100 lm / 600 cd WW2 1100 lm / 600 cd NW2 1100 lm / 600 cd TW |
| Version | T BI | track mount built in monopoint (plasterkit required) | |
| Dimming | IC OC | fixtures individually dimmable, controlled by DALI DT8 track overall control. dimming possible with 0/1-10V, potentiometer or DALI, on 2 circuits (see pag. 76) | |
| Accessories | PL.300 KNICK.FI KNICK.MP | monopoint plasterkit 300 mm interchangeable frosted ice diffuser interchangeable microprism diffuser | |

°knick small

material aluminium coated
 weight 350gr / 0.77lb
 voltage 24Vdc
 cri >90
 wattage 9,6W
 inclination 90°
 dali supported (option) DT6
 certifications CE, ENEC
 classifications IP20

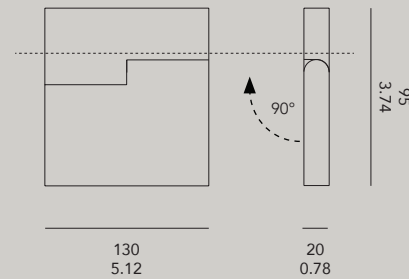

KNICK.S.L.C.D.V.D

| | | | | |
|-------------|---------------|--|------------|------------------|
| Led | WW | 2700K 9,6W | | |
| | WW2 | 3000K 9,6W | | |
| | NW2 | 4000K 9,6W | | |
| Color body | BK | black matt ral 9011 | | |
| | WH | white matt ral 9016 | | |
| | AL | aluminium color ral 9006 (on request only) | | |
| Diffuser | FI | frosted ice diffuser (wide beam) | WW | 1300 lm / 530 cd |
| | | | WW2 | 1300 lm / 530 cd |
| | | | NW2 | 1300 lm / 530 cd |
| | MP | microprism diffuser (wide beam & anti-glare) | WW | 1300 lm / 600 cd |
| | | | WW2 | 1300 lm / 600 cd |
| | | | NW2 | 1300 lm / 600 cd |
| | 25 | optic 25° | WW | 785 lm / 2940 cd |
| | | | WW2 | 825 lm / 3075 cd |
| | | | NW2 | 865 lm / 3150 cd |
| | 45 | optic 45° | WW | 450 lm / 560 cd |
| | | | WW2 | 600 lm / 855 cd |
| | | | NW2 | 640 lm / 860 cd |
| Version | T | track mount | | |
| | BI | built in monopoint (plasterkit required) | | |
| Dimming | IC | fixtures individually dimmable, controlled by DALI DT6 | | |
| | OC | track overall control. dimming possible with 0/1-10V, potentiometer or DALI, on 2 circuits (see pag. 76) | | |
| Accessories | PL.130 | monopoint plasterkit 130 mm | | |

material aluminium coated
 weight 260gr / 0.57lb
 voltage 24Vdc
 cri >90
 wattage 16,5W
 dali supported (option) DALI DT8, tunable white
 certifications CE, ENEC
 classifications IP20

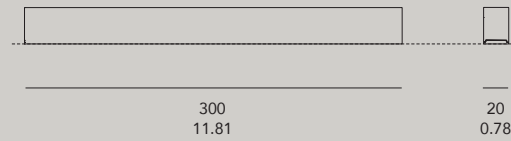

IN.L.C.D.V.D

| | | | | |
|-------------|---------------|--|-----|------------------|
| Led | WW | 2700K 16,5W | | |
| | WW2 | 3000K 16,5W | | |
| | NW2 | 4000K 16,5W | | |
| | TW | tunable white (only with IC) 18W 2200-6500°K | | |
| Color body | BK | black matt ral 9011 | | |
| | WH | white matt ral 9016 | | |
| | AL | aluminium color ral 9006 (on request only) | | |
| Diffuser | FI | frosted ice diffuser | WW | 1300 lm / 530 cd |
| | | (wide beam) | WW2 | 1300 lm / 530 cd |
| | | | NW2 | 1300 lm / 530 cd |
| | | | TW | |
| | MP | microprism diffuser | WW | 1300 lm / 600 cd |
| | | (wide beam & anti-glare) | WW2 | 1300 lm / 600 cd |
| | | | NW2 | 1300 lm / 600 cd |
| | | | TW | |
| Version | T | track mount | | |
| | BI | built in monopoint (plasterkit required) | | |
| Dimming | IC | fixtures individually dimmable, controlled by DALI DT8 | | |
| | OC | track overall control. dimming possible with 0/1-10V, potentiometer or DALI, on 2 circuits (see pag. 76) | | |
| Accessories | PL.300 | monopoint plasterkit 300 mm | | |
| | IN.FI | interchangeable frosted ice diffuser | | |
| | IN.MP | interchangeable microprism diffuser | | |

°in small

material aluminium coated
 weight 140gr / 0.31lb
 voltage 24Vdc
 cri >90
 wattage 10W
 dali supported (option) DT8
 certifications CE  
 classifications IP20 

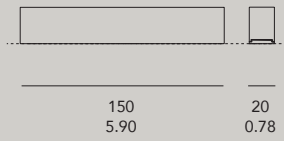

IN.S.L.C.D.V.D

| | | | | |
|-------------|----------------|---|-----|-----------------|
| Led | WW | 2700K 10W | | |
| | WW2 | 3000K 10W | | |
| | NW2 | 4000K 10W | | |
| Color body | BK | black matt ral 9011 | | |
| | WH | white matt ral 9016 | | |
| | AL | aluminium color ral 9006 (on request only) | | |
| Diffuser | FI | frosted ice diffuser (wide beam) | WW | 485 lm / 180 cd |
| | | | WW2 | 510 lm / 190 cd |
| | | | NW2 | 535 lm / 200 cd |
| | MP | microprism diffuser (wide beam & anti-glare) | WW | 485 lm / 180 cd |
| | | | WW2 | 510 lm / 190 cd |
| | | | NW2 | 535 lm / 200 cd |
| Version | T | track mount | | |
| | BI | built in monopoint (plasterkit required) | | |
| Dimming | IC | fixtures individually dimmable, controlled by DALI DT8 track overall control. dimming possible with 0/1-10V, potentiometer or DALI, on 2 circuits (see pag. 76) | | |
| | OC | | | |
| Accessories | PL.150 | monopoint plasterkit 150 mm | | |
| | IN.S.FI | interchangeable frosted ice diffuser | | |
| | IN.S.MP | interchangeable microprism diffuser | | |

turn

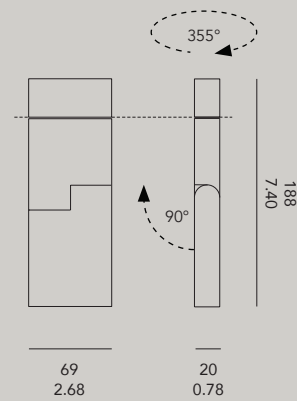

material aluminium coated
 weight 380gr / 0,83lb
 voltage 24Vdc
 cri >90
 wattage 9,6W
 dali supported (option) DT6
 rotation 355°
 inclination 90°
 certifications CE  
 classifications IP20 



TURN.L.C.B.V.D

| | | | | |
|-------------|----------------|---|-----------------|------------------|
| Led | WW | 2700K 9,6W | | |
| | WW2 | 3000K 9,6W | | |
| | NW2 | 4000K 9,6W | | |
| Color body | BK | black matt ral 9011 | | |
| | WH | white matt ral 9016 | | |
| | AL | aluminium color ral 9006 (on request only) | | |
| Beam | FI | frosted ice diffuser (wide beam) | WW | 750 lm / 2700 cd |
| | | | WW2 | 790 lm / 2820 cd |
| | | | NW2 | 830 lm / 2900 cd |
| | MP | microprism diffuser (wide beam & anti-glare) | WW | 680 lm / 1100 cd |
| | | | WW2 | 735 lm / 1665 cd |
| | | | NW2 | 770 lm / 1765 cd |
| | 25 | optic 25° | WW | 485 lm / 180 cd |
| | | | WW2 | 510 lm / 190 cd |
| | 40 | optic 40° | NW2 | 535 lm / 200 cd |
| | | | WW | 485 lm / 180 cd |
| | | | WW2 | 510 lm / 190 cd |
| | | NW2 | 535 lm / 200 cd | |
| Version | T | track mount | | |
| | BI | built in monopoint (plasterkit required) | | |
| Dimming | IC | fixtures individually dimmable, controlled by DALI DT6 track overall control. dimming possible with 0/1-10V, potentiometer or DALI, on 2 circuits (see pag. 76) | | |
| | OC | | | |
| Accessories | PL.70 | monopoint plasterkit 70 mm | | |
| | TURN.25 | interchangeable additional optics 25° | | |
| | TURN.40 | interchangeable additional optics 40° | | |
| | TURN.FI | interchangeable frosted ice diffuser | | |
| | TURN.MP | interchangeable microprism diffuser | | |

turn plus ^{NEW}

material aluminium coated / PC
 weight 450gr/0,99lb
 voltage 24Vdc
 cri 92
 wattage 13W
 dali supported DT6 (option)
 rotation 355°
 inclination 90°
 certifications CE 
 classifications IP20 

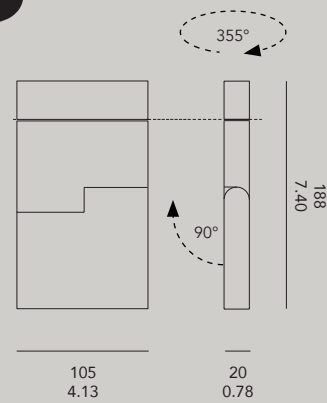

TURN.PL.L.B.O.V.C

| | | | | |
|-------------|---------------|--|-----|-------------------|
| Led | WW | 2700K 13W | | |
| | WW2 | 3000K 13W | | |
| | NW2 | 4000K 13W | | |
| Body color | BK | black matt ral 9011 | | |
| | WH | white matt ral 9016 | | |
| | AL | aluminium color ral 9006 (on request only) | | |
| Optics | 10 | optic 10° | WW | 855 lm / 21400 cd |
| | | | WW2 | 940 lm / 23700 cd |
| | | | NW2 | 960 lm / 24750 cd |
| | 25 | optic 25° | WW | 680 lm / 2580 cd |
| | | | WW2 | 720 lm / 2700 cd |
| | | | NW2 | 755 lm / 2835 cd |
| | 35 | optic 35° | WW | 528 lm / 1540 cd |
| | | | WW2 | 690 lm / 1600 cd |
| | | | NW2 | 725 lm / 1680 cd |
| Version | T | track mount | | |
| | BI | built in monopoint (plasterkit required) | | |
| Control | IC | individually controlled fixture by DALI DT6 | | |
| | OC | track overall control. dimming possible with 0/1-10V, potentiometer or DALI, on 2 circuits (see pag. 76) | | |
| Accessories | PL.105 | monopoint plasterkit 105 mm | | |

°turn sora

NEW

| | |
|-----------------|--|
| material | aluminium coated |
| weight | 380gr |
| voltage | 24Vdc |
| cri | 95 |
| wattage | 10 / 16W |
| dali | supported (no 0-10V dimming, only DALI) |
| rotation | 355° |
| inclination | 90° |
| certifications | CE |
| classifications | IP20  |

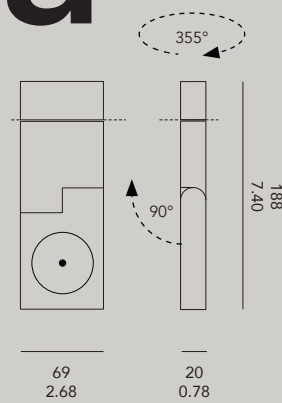

TURN.SO.L.B.V.C

| | | |
|-------------|--------------|---|
| Led | 10-27 | 10°, 2700K, SNAP compatible, max. 10W |
| | 10-30 | 10°, 3000K, SNAP compatible, max. 10W |
| | 10-40 | 10°, 4000K, SNAP compatible, max. 10W |
| | 15-27 | 15°, 2700K, SNAP compatible, max. 16W |
| | 15-30 | 15°, 3000K, SNAP compatible, max. 16W |
| | 15-40 | 15°, 4000K, SNAP compatible, max. 16W |
| Body color | BK | black matt ral 9011 |
| | WH | white matt ral 9016 |
| | AL | aluminium color ral 9006 (on request only) |
| Version | T | track mount |
| | BI | built in monopoint (plasterkit required) |
| Control | IC | individually controlled fixture by DALI DT6 |
| | OC | track overall controlled (if provided), no dimming possible |
| Accessories | PL.70 | monopoint plasterkit 70 mm |

Snap system for turn soraa

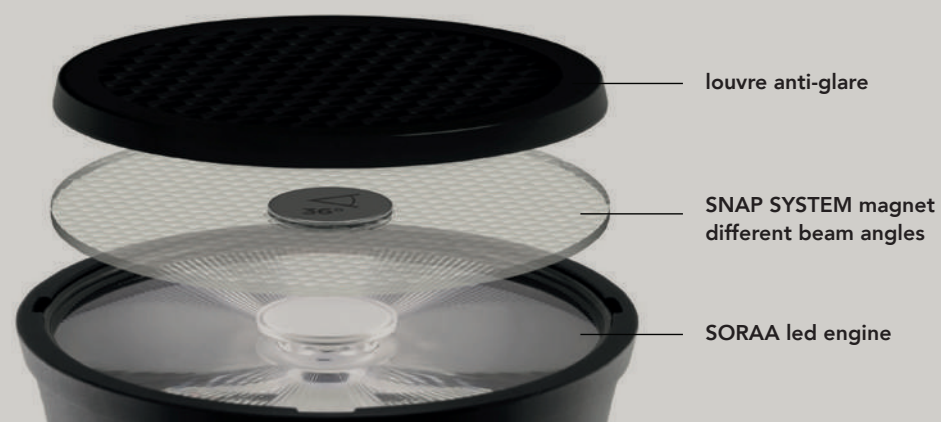

Soraa has developed an optical system that is optimized around its breakthrough GaN-on-GaN™ LED technology. The result is directional light with near perfect light distribution, exquisitely uniform color and smooth, artifact free transitions. The optical light engines deliver intensity normally associated with substantially larger diameter sources. Beam angles range from narrow spot to flood and can be combined with the SNAP System accessories to change light distribution and light color on site.

The SNAP SYSTEM's self-centering magnetic interconnect system makes using accessories completely user friendly. Simply attached the SNAP SYSTEM accessory directly to the led engine, the magnetic force from both the accessory and lamp will securely attached to one another and center itself. The accessories can be stacked in combination. For example, a beam spreader can be used in combination with CCT shifter.

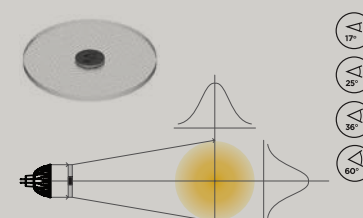

Use in any application where reducing the number of beam angle SKUs is required. Provides maximum flexibility up to the time of installation.

- TURN.SO.17** SNAP beam spreader 17°
- TURN.SO.25** SNAP beam spreader 25°
- TURN.SO.36** SNAP beam spreader 36°
- TURN.SO.60** SNAP beam spreader 60°

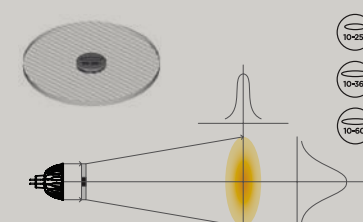

Use in wall washes and illuminating asymmetric objects. Reduces required number of light fixtures and spill.

- TURN.SO.1025** SNAP linear 10°x 25°
- TURN.SO.1036** SNAP linear 10°x 36°
- TURN.SO.1060** SNAP linear 10°x 60°

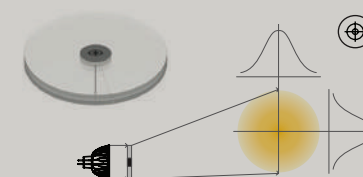

Designed with two lenses the AIM snap bends the beam from 0 degree to maximum deflection angle of 20 degrees, while maintaining uniform and consistent color and shape.

- TURN.SO.AIM** deflection angle of 20°

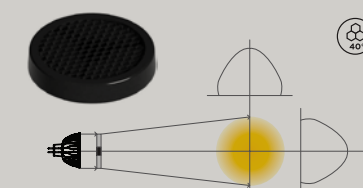

Eliminates high angle glare, making light beams disappear in downlight applications.

- TURN.SO.LOUVRE** SNAP anti-glare louvre

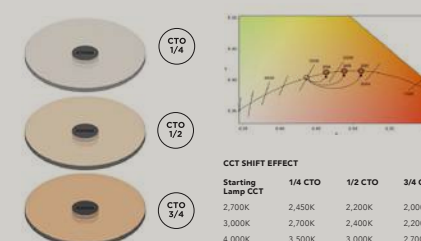

Use in hospitality and restaurant applications to simulate warm dimming. Create custom colors for festive occasions or brand identity.

- TURN.SO.CS.1/4** SNAP color shift small
- TURN.SO.CS.1/2** SNAP color shift medium
- TURN.SO.CS.3/4** SNAP color shift large

°out

material aluminium coated
 weight 450gr / 0.99lb
 voltage 24Vdc
 cri >90
 wattage 16,5W
 dali supported (option) DALI DT8, tunable white
 certifications CE   
 classifications IP20 

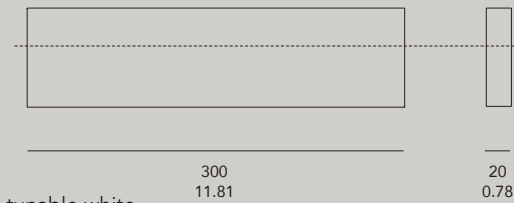

°out (FI)

OUT.L.C.D.V.D

| | | | | |
|-------------|---|---|------------------|------------------|
| Led | WW | 2700K 16,5W | | |
| | WW2 | 3000K 16,5W | | |
| | NW2 | 4000K 16,5W | | |
| | TW | tunable white (only with IC) 18W 2200-6500°K | | |
| Color body | BK | black matt ral 9011 | | |
| | WH | white matt ral 9016 | | |
| | AL | aluminium color ral 9006 (on request only) | | |
| Diffuser | FI | strip frosted ice | WW | 1100 lm / 600 cd |
| | | | WW2 | 1100 lm / 600 cd |
| | | | NW2 | 1100 lm / 600 cd |
| | | | TW | |
| | MP | strip microprism (anti-glare) | WW | 1100 lm / 600 cd |
| | | | WW2 | 1100 lm / 600 cd |
| | | | NW2 | 1100 lm / 600 cd |
| | | | TW | |
| | SF | solid frosted | WW | 1100 lm / 275 cd |
| | | | WW2 | 1160 lm / 290 cd |
| | | | NW2 | 1220 lm / 305 cd |
| | | | TW | |
| SC | solid clear | WW | 930 lm / 395 cd | |
| | | WW2 | 980 lm / 415 cd | |
| | | NW2 | 1030 lm / 435 cd | |
| | | TW | | |
| SCE | solid clear with custom etched front (300x50mm) | WW | 930 lm / 395 cd | |
| | | WW2 | 980 lm / 415 cd | |
| | | NW2 | 1030 lm / 435 cd | |
| | | TW | | |
| Version | T | track mount | | |
| | BI | built in monopoint (plasterkit required) | | |
| Dimming | IC | fixtures individually dimmable, controlled by DALI DT8 track overall control. dimming possible with 0/1-10V, potentiometer or DALI, on 2 circuits (see pag. 76) | | |
| | OC | | | |
| Accessories | PL.300 | monopoint plasterkit 300 mm | | |
| | OUT.FI | interchangeable frosted ice diffuser | | |
| | OUT.MP | interchangeable microprism diffuser | | |



°out with solid clear diffuser with custom etched front (SCE)



°out with solid frost diffuser (SF)

°u-disk NEW

material aluminium coated / PMMA
 weight 300gr / 0.66lb
 voltage 24Vdc
 cri >90
 wattage 13W
 dali supported DT6
 rotation 355°
 inclination 90°
 certifications CE, RoHS
 classifications IP20

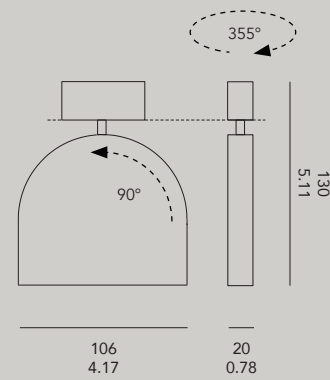

UDISK.L.B.O.V.C

| | | | | |
|-------------|--------------|--|-----|-------------------|
| Led | WW | 2700K 13W | | |
| | WW2 | 3000K 13W | | |
| | NW2 | 4000K 13W | | |
| Body color | BK | black matt ral 9011 | | |
| | WH | white matt ral 9016 | | |
| | AL | aluminium color ral 9006 (on request only) | | |
| Optics | 10 | optic 10° | WW | 855 lm / 21400 cd |
| | | | WW2 | 940 lm / 23700 cd |
| | | | NW2 | 960 lm / 24750 cd |
| | 25 | optic 25° | WW | 680 lm / 2580 cd |
| | | | WW2 | 720 lm / 2700 cd |
| | | | NW2 | 755 lm / 2835 cd |
| | 35 | optic 35° | WW | 528 lm / 1540 cd |
| | | | WW2 | 690 lm / 1600 cd |
| | | | NW2 | 725 lm / 1680 cd |
| Version | T | track mount | | |
| | BI | built in monopoint (plasterkit required) | | |
| Control | IC | individually controlled fixture by DALI DT6 | | |
| | OC | track overall control. dimming possible with 0/1-10V, potentiometer or DALI, on 2 circuits (see pag. 76) | | |
| Accessories | PL.70 | monopoint plasterkit 70 mm | | |

o-disk ^{NEW}

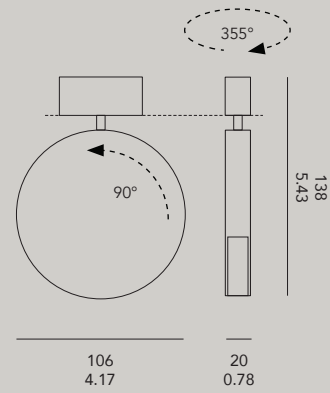

material aluminium coated / PMMA
 weight 300gr / 0.66lb
 voltage 24Vdc
 cri >90
 wattage 13W
 dali supported DT6
 rotation 355°
 inclination 90°
 certifications CE
 classifications IP20 



ODISK.L.B.D.V.C

| | | | | |
|-------------|--------------|--|------------|-----------------|
| Led | WW | 2700K 9,6W | | |
| | WW2 | 3000K 9,6W | | |
| | NW2 | 4000K 9,6W | | |
| Body color | BK | black matt ral 9011 | | |
| | WH | white matt ral 9016 | | |
| | AL | aluminium color ral 9006 (on request only) | | |
| Diffuser | FI | frosted ice diffuser (wide beam) | WW | 245 lm / 150 cd |
| | | | WW2 | 255 lm / 160 cd |
| | | | NW2 | 270 lm / 165 cd |
| Version | T | track mount | | |
| | BI | built in monopoint (plasterkit required) | | |
| Control | IC | individually controlled fixture by DALI DT6 | | |
| | OC | track overall control. dimming possible with 0/1-10V, potentiometer or DALI, on 2 circuits (see pag. 76) | | |
| Accessories | PL.70 | monopoint plasterkit 70 mm | | |

°dot

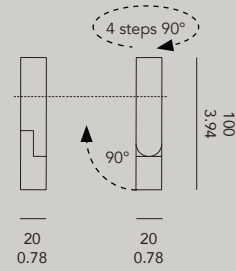

material aluminium coated
 weight 80gr / 0.17lb
 voltage 24Vdc
 cri >90
 wattage 3,6W
 dali not supported
 rotation 4 steps of 90°
 inclination 90°
 certifications 
 classifications IP20 



DOT.L.B.D.V

| | | |
|-------------|---------------------------------------|--|
| Led | WW WW2 NW2 | 2700K 3,6W 100 lm - 2353 cd - 8° 3000K 3,6W 105 lm - 2670 cd - 8° 4000K 3,6W 110 lm - 2800 cd - 8° |
| Body color | BK WH AL | black matt ral 9011 white matt ral 9016 aluminium color ral 9006 (on request only) |
| Dimming | OC | track overall control. dimming possible with 0/1-10V, potentiometer, on 2 circuits (see pag. 76) |
| Version | T BI | track mount built in monopoint (plasterkit required) |
| Accessories | PL.DOT | monopoint plasterkit °dot |

°dot turn NEW

material aluminium coated
 weight 170gr / 0.37lb
 voltage 24Vdc
 cri >90
 wattage 3W
 dali supported DT6
 rotation 355°
 inclination 90°
 certifications CE 
 classifications IP20 

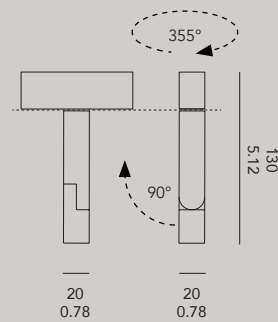

DOT.TURN.L.B.D.V

| | | |
|-------------|-------------------|---|
| Led | WW | 2700K 3,6W 100 lm - 2353 cd - 8° |
| | WW2 | 3000K 3,6W 105 lm - 2670 cd - 8° |
| | NW2 | 4000K 3,6W 110 lm - 2800 cd - 8° |
| Body color | BK | black matt ral 9011 |
| | WH | white matt ral 9016 |
| | AL | aluminium color ral 9006 (on request only) |
| Dimming | IC | fixtures individually dimmable, controlled by DALI DT6 track overall control. dimming possible with 0/1-10V, potentiometer, on 2 circuits (see pag. 76) |
| | OC | |
| Version | T | track mount |
| | BI | built in monopoint (plasterkit required) |
| Accessories | PL.DOTTURN | monopoint plasterkit °dot turn |

power supply 24Vdc

PS.24.XX.SM.HLG 1-10V dimming, CE, cUL certified, 90-305VAC

| | | |
|-----|---|--------------------------|
| 40 | W | 171*61.5*36.8 mm (L*W*H) |
| 60 | W | 171*61.5*36.8 mm |
| 80 | W | 195.6*61.5*38.8 mm |
| 100 | W | 220*68*38.8 mm |
| 150 | W | 228*68*38.8 mm |
| 240 | W | 244.2*68*38.8 mm |
| 320 | W | 252*90*43.8 mm |
| 600 | W | 280*144*48.5mm |

DAP04 dali adaptor for dali control of power supply HLG (165*46*23 mm)

PS.24.XX.SM.ELG 0-10V dimming, CE, cUL, CCC certified, 110-305VAC

| at 240V | at 110V | |
|---------|---------|-----------------------|
| 75W | 60W | 180*63*35.5mm (L*W*H) |
| 100W | 70W | 199*63*35.5mm |
| 150W | 105W | 219*63*35.5mm |
| 200W | 150W | 244*71*37.5mm |
| 240W | 180W | 244*71*37.5mm |

PS.24.XX.SM.ELG.DA DALI dimming, CE, cUL, CCC certified, 110-305VAC

| at 240V | at 110V | |
|---------|---------|-----------------------|
| 75W | 60W | 180*63*35.5mm (L*W*H) |
| 100W | 70W | 199*63*35.5mm |
| 150W | 105W | 219*63*35.5mm |
| 200W | 150W | 244*71*37.5mm |
| 240W | 180W | 244*71*37.5mm |

PS.24.SM.B.DIM Potentiometer dimming button (0-10V/1-10V)

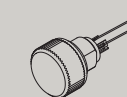

LDIM.24V DIN rail mount dimmodule 24 VDC Max 240W controlled by 0/1-10V or potentiometer (width 25mm)

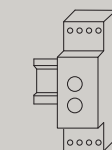

°bloc NEW

The first linear lighting system available in a wide variety of high quality materials to offer a solution to your unique requirements.

Interchangeable °bloc units clip onto a surface mounted track.

Design by etre moderne



NEW



°BLOC.SPOT walnut & brass brushed & °BLOC walnut & white carrara
House, Belgium - architect Pascal François - photograph by Thomas De Bruyne (cafeine.be)



Stone workshop

Wood workshop



Polishing brass

Milling wood

**We use natural materials,
selected with the greatest care.**

**They are being processed in local workshops
by professional craftsmen.**

scale 1/1

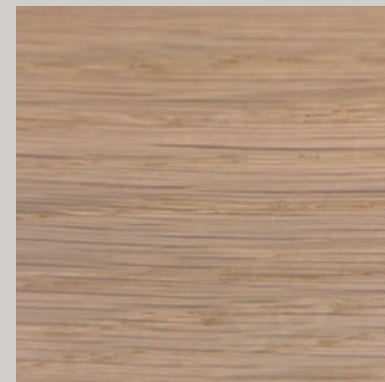

European oak (FSC 100%)

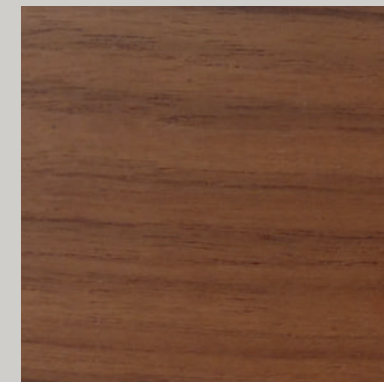

American walnut (FSC 100%)

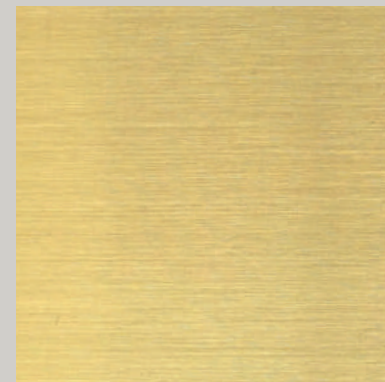

Brass brushed

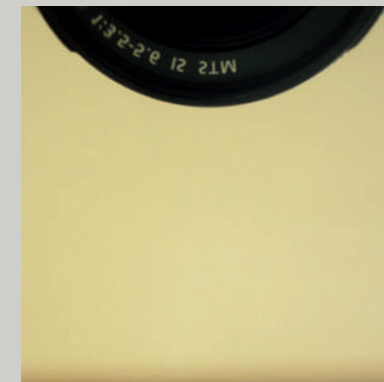

Brass polished

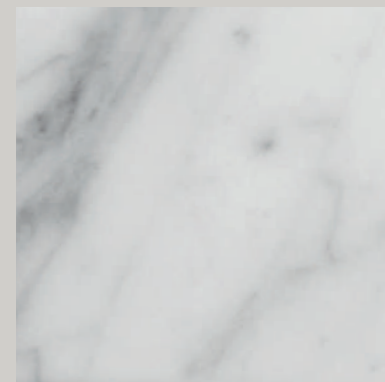

Italian Bianco Carrara "C"

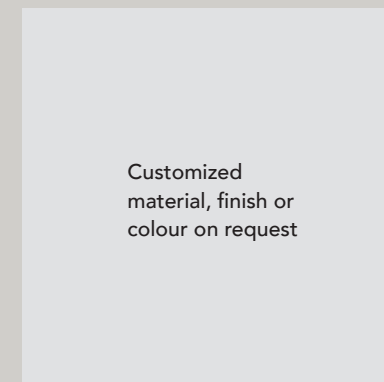

Differences in colors and patterns may occur since these are natural materials.

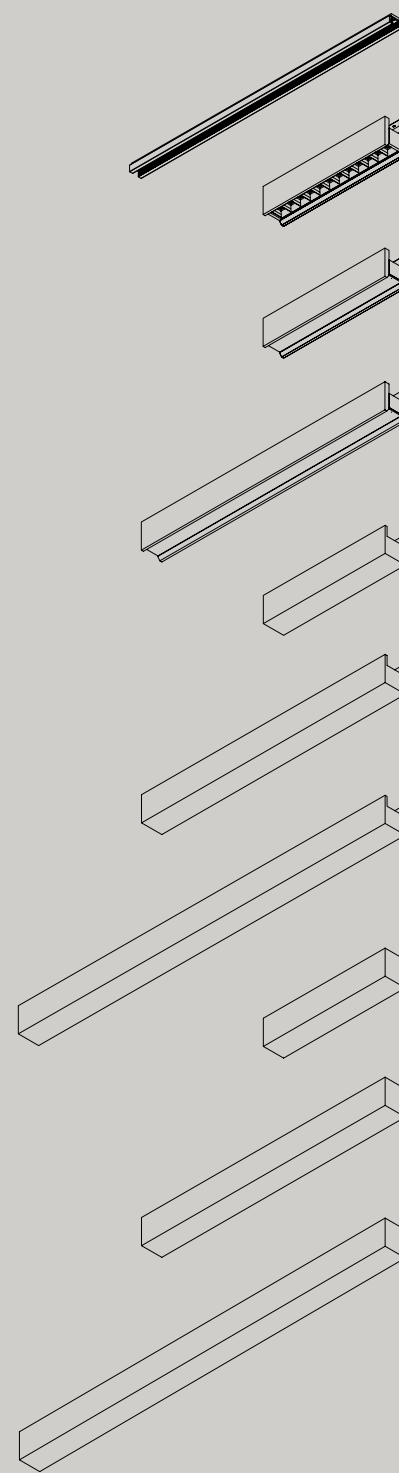

track

bloc spot
300 mm
20° or 40°, both with a black anti-glare louvre

bloc stripe
300 mm
frosted ice or microprism diffuser

bloc stripe
600 mm
frosted ice or microprism diffuser

bloc
300 mm

bloc
600 mm

bloc
900 mm

bloc end
300 mm

bloc end or bloc with integrated driver
600 mm

bloc end
900 mm

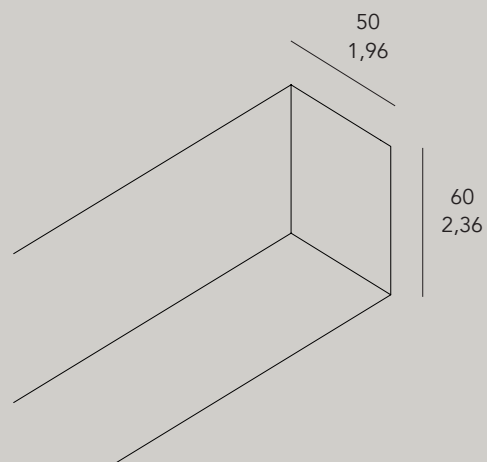

BLOC.SPOT.300.L.M.B Bloc led **spot** 24Vdc

| | | | | |
|-----------------|---------------|---|-----|-------------------|
| Led | WW | 2700K 13W | | |
| | WW2 | 3000K 13W | | |
| | NW2 | 4000K 13W | | |
| Length* | 300 | mm | | |
| Material | BRA-BR | brass brushed, clear matt varnished | | |
| | BRA-HP | brass high polished, clear varnished | | |
| | OAK | european oak massive, clear matt varnished | | |
| | WAL | american walnut massive, clear matt varnished | | |
| | CAR | italian white carrara C, matt sweetened | | |
| | WHI | aluminium, white coated | | |
| | BLA | aluminium, black coated | | |
| Beam | 20° | spot 20° | WW | 1000 lm / 3200 cd |
| | | with black anti-glare louvre | WW2 | 1036 lm / 3329 cd |
| | | | NW2 | 1120 lm / 3500 cd |
| | 40° | spot 40° | WW | 700 lm / 365 cd |
| | | with black anti-glare louvre | WW2 | 730 lm / 380 cd |
| | | | NW2 | 785 lm / 410 cd |

BLOC.STRP.L.L.M.D Bloc led **stripe** 24Vdc

| | | | | |
|-----------------|---------------|---|-----|-----------------|
| Led | WW | 2700K | | |
| | WW2 | 3000K | | |
| | NW2 | 4000K | | |
| Length* | 300 | mm | 13W | |
| | 600 | mm | 26W | |
| Material | BRA-BR | brass brushed, clear matt varnished | | |
| | BRA-HP | brass high polished, clear varnished | | |
| | OAK | european oak massive, clear matt varnished | | |
| | WAL | american walnut massive, clear matt varnished | | |
| | CAR | italian white carrara C, matt sweetened | | |
| | WHI | aluminium, white coated | | |
| | BLA | aluminium, black coated | | |
| Diffuser | FI | frosted ice diffuser (wide angle) | WW | 700 lm / 365 cd |
| | | | WW2 | 730 lm / 380 cd |
| | | | NW2 | 785 lm / 410 cd |
| | MP | microprism diffuser (wide angle & anti-glare) | WW | 700 lm / 365 cd |
| | | | WW2 | 730 lm / 380 cd |
| | | | NW2 | 785 lm / 410 cd |



| BLOC.L.M.V | | Bloc without light |
|------------|---------------|--|
| Length | 300 | mm |
| | 600 | mm |
| | 900 | mm |
| | custom | on request (possible lengths depend on the kind of material) |
| Material | BRA-BR | brass brushed, clear matt varnished |
| | BRA-HP | brass high polished, clear varnished |
| | OAK | european oak massive, clear matt varnished |
| | WAL | american walnut massive, clear matt varnished |
| | CAR | italian white carrara C, matt sweetened |
| | WHI | aluminium, white coated |
| | BLA | aluminium, black coated |
| Version | END | bloc closed at one side (at the beginning or the end of the track) |

| BLOC.LD.M.LD | | Bloc with an integrated led driver 600 mm |
|--------------|---------------|---|
| Material | BRA-BR | brass brushed, clear matt varnished |
| | BRA-HP | brass high polished, clear varnished |
| | OAK | european oak massive, clear matt varnished |
| | WAL | american walnut massive, clear matt varnished |
| | CAR | italian white carrara C, matt sweetened |
| | WHI | aluminium, white coated |
| | BLA | aluminium, black coated |
| Led Driver | US | 100W input 110-240 Vdc DALI supported |
| | EU | 100W input 220-240 Vdc DALI supported |
| | 24V | remote, see p. 76 |

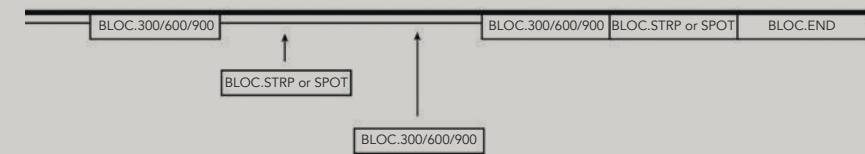

- BLOC.STRP or BLOC.SPOT don't fit to each other;
these must be always separated by a BLOC (without led)

- BLOC.END isn't available with led.



°BLOC.STRIPE brass brushed & °BLOC walnut
 House Aalst, Belgium - architect Pascal François - photograph by Jeroen Verrecht



BLOC.STRP.300 with frosted ice diffuser



BLOC.STRP.600, with frosted ice diffuser



BLOC.SPOT.300, 20° or 40°, with black anti-glare louvre

°hide-out ^{NEW}

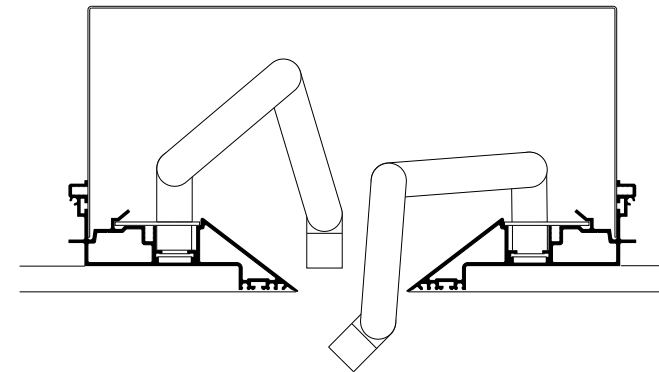

Hide-out is a 24 Vdc recessed track system which offers a great flexibility in terms of moving around the LED lighting fixtures 'nook' and 'tag' since they don't have a power cable. This means that any person can move the lighting fixtures since there is no need of connecting wires. The lighting fixtures have a hinge system which makes that you can hide them inside the ceiling or pull them out. Optionally available with indirect ambient lighting. Hide-out is available in black and white.

Design by Eden Design

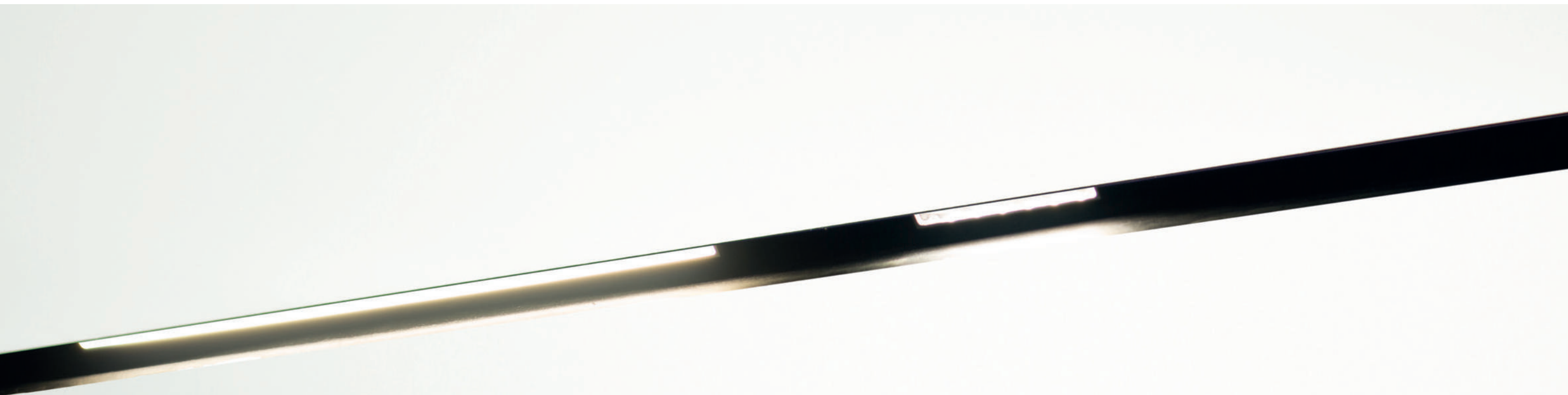
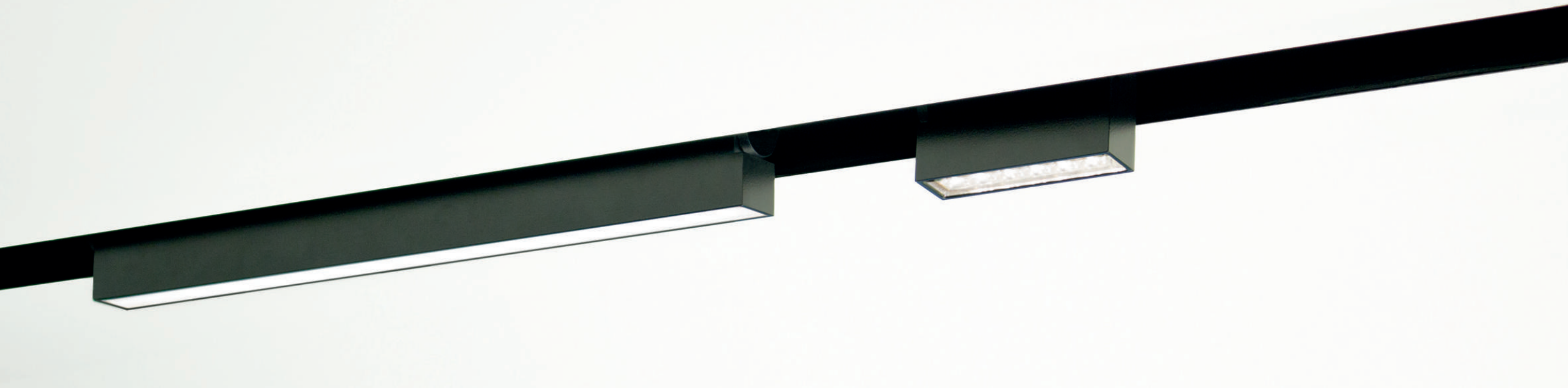



°hide-out ^{NEW}

material aluminium coated
 weight 80gr / 0.17lb
 voltage 24Vdc
 max 240W (on length of 4m)
 dimming 1-10V / 0-10V / DALI
 certifications CE 
 classifications IP20 

HIDEOUT single track

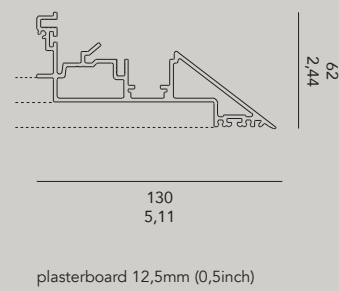

plasterboard 12,5mm (0,5inch)

HIDEOUT double track with cover

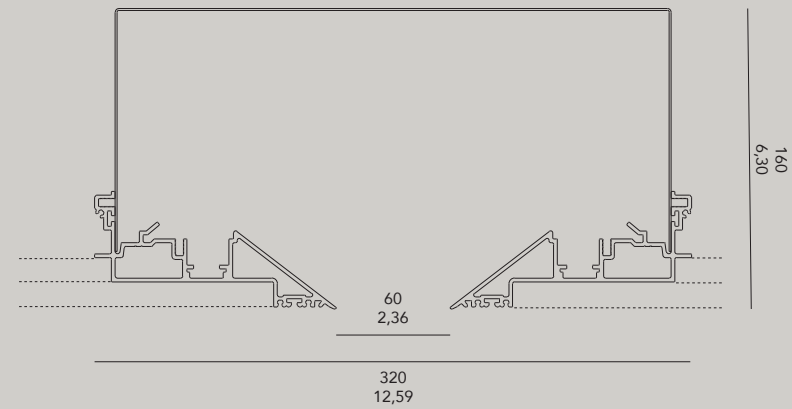

HIDEOUT.L.C.V

| | | |
|------------|------------------|---------------------------------------|
| Length | 4000 | standard length in mm |
| | 300 - ... | custom length in mm |
| Color body | BK | black matt ral 9011 |
| | WH | white matt ral 9016 |
| | AL | aluminium color ral 9006 (on request) |
| Version | SI | single track |
| | DU | double track |

Cover

HIDE.OUT.CO.WH
 HIDE.OUT.CO.BL

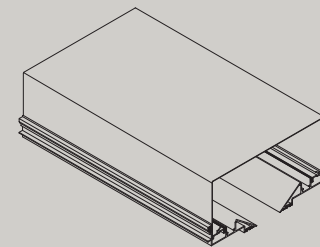

End Cap

HIDE.OUT.EC.WH
 HIDE.OUT.EC.BL

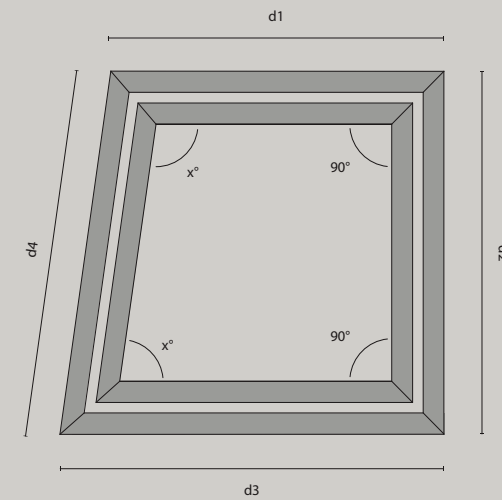
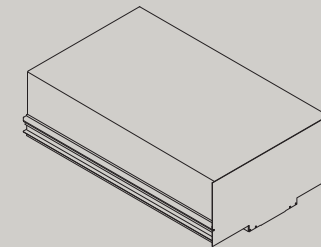

Mention the outside dimensions of the tracks and the inner corners

°nook NEW

material aluminium coated
 weight 400 gr
 voltage 24Vdc
 cri >90
 wattage 18W
 dali supported DT8 (option) tunable white
 certifications C E
 classifications IP20 

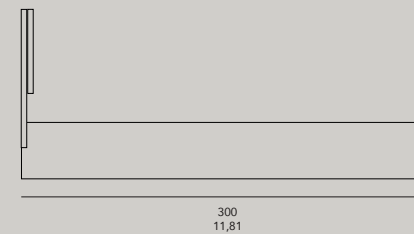
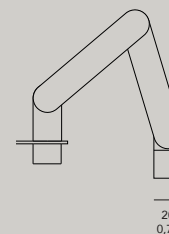

NOOK.L.C.D.D

| | | | | |
|-------------------|------------|--|------------|------------------|
| Led | WW | 2700K 16,5W | | |
| | WW2 | 3000K 16,5W | | |
| | NW2 | 4000K 16,5W | | |
| | TW | tunable white (only with IC) 18W 2200-6500°K | | |
| Color body | BK | black matt ral 9011 | | |
| | WH | white matt ral 9016 | | |
| | AL | aluminium color ral 9006 (on request only) | | |
| Diffuser | FI | frosted ice diffuser (wide beam) | WW | 1300 lm / 530 cd |
| | | | WW2 | 1300 lm / 530 cd |
| | | | NW2 | 1300 lm / 530 cd |
| | | | TW | |
| | MP | microprism diffuser (wide beam & anti-glare) | WW | 1300 lm / 600 cd |
| | | | WW2 | 1300 lm / 600 cd |
| | | | NW2 | 1300 lm / 600 cd |
| | | | TW | |
| Dimming | IC | fixtures individually dimmable, controlled by DALI DT8 | | |
| | OC | track overall control. dimming possible with 0/1-10V, potentiometer or DALI, on 2 circuits (see pag. 76) | | |

o'tag NEW

material aluminium coated
 weight 200gr
 voltage 24Vdc
 cri >90
 wattage 9,6W
 dali supported DT6
 certifications C€
 classifications IP20 

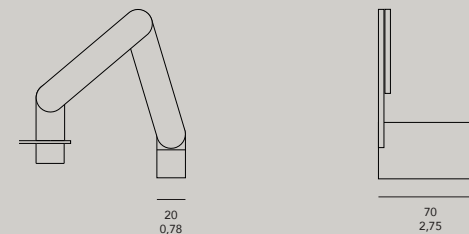

TAG.L.C.D.D

| | | | | |
|------------|------------|--|-----|------------------|
| Led | WW | 2700K 9,6W | | |
| | WW2 | 3000K 9,6W | | |
| | NW2 | 4000K 9,6W | | |
| Color body | BK | black matt ral 9011 | | |
| | WH | white matt ral 9016 | | |
| | AL | aluminium color ral 9006 (on request only) | | |
| Diffuser | 25° | 25° lens | WW | 750 lm / 2700 cd |
| | | | WW2 | 790 lm / 2820 cd |
| | | | NW2 | 830 lm / 2900 cd |
| | 40° | 40° lens | WW | 680 lm / 1100 cd |
| | | | WW2 | 735 lm / 1665 cd |
| | | | NW2 | 770 lm / 1765 cd |
| Dimming | IC | fixtures individually dimmable, controlled by DALI | | |
| | OC | track overall control. dimming possible with 0/1-10V, potentiometer or DALI, on 2 circuits (see pag. 76) | | |

°ledline

Continuous lines of light, without limits.

Each led module can be cut every 8 cm, this gives architects and lighting designers a lot of flexibility.

Led line has a very good efficiency. A high-tech diffuser was implemented to block as little light as possible and still give an opal look.

Led line can be installed surface mounted, recessed and pendant. It is available in two control options: DALI & 1-10V. Available in anodized aluminum, black or white.



°led line 25



°led line 60



°led line 60



°led line 60 with rounded corner

°ledline 25

material anodised aluminium coated
 weight 0,8 kg/m - 0,52 lb/ft
 voltage 24Vdc
 cri >90
 wattage 13 or 28W / meter
 dali supported DT6 option
 certifications CE, RoHS, ENEC
 classifications IP20

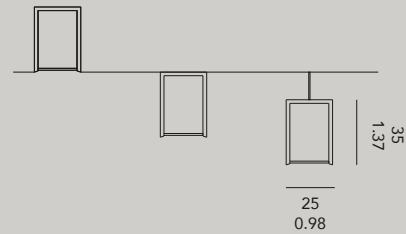

| | | |
|---------------------|--|---|
| LL25.L.B.T.K | | led modules cuttable every 8 cm |
| Length | 2000 100 - ... | standard length custom length |
| Body color | BK WH AL | black matt ral 9011 white matt ral 9016 aluminium color ral 9006 (on request only) |
| Type | BI SM PD | recessed surface mount pendant |
| K | WW.13 WW2.13 NW2.13 WW.28 WW2.28 NW2.28 | 2700K 13W 960 lm/m 3000K 13W 1020 lm/m 4000K 13W 1020 lm/m 2700K 28W 1650 lm/m 3000K 28W 1780 lm/m 4000K 28W 1850 lm/m |
| Accessories | LL25.EC.BK LL25.EC.WH LL25.EC.AL LL25.MB | led line 25 End Cap Black led line 25 End Cap White led line 25 End Cap Aluminium Mounting Bracket for recessed mounting |
| Driver | See p. 76 | |

°ledline 60

material anodised aluminium coated
 weight 2,5 kg/m - 1,65 lb/ft
 voltage 240 Vdc
 cri >90
 wattage 28W / meter
 dali supported DT6 option
 certifications CE, RoHS, ENEC
 classifications IP20

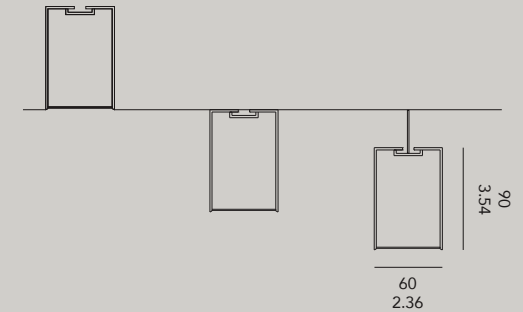

| | | |
|-----------------------|--|--|
| LL60.L.B.T.K.D | | led modules cuttable every 8 cm |
| Length | 2000 100 - ... | standard length custom length |
| Body color | BK WH AL | black matt ral 9011 white matt ral 9016 aluminium color anodised (on request only) |
| Type | BI SM PD | recessed surface mount pendant |
| K | WW.28 WW2.28 NW2.28 | 2700K 28W 1650 lm/m 3000K 28W 1780 lm/m 4000K 28W 1850 lm/m |
| Driver (integrated) | ND DA DA2 10V | Non dimmable 100-240VAC DALI 220-240VAC DALI 100-240VAC 1-10V 100-240VAC |
| Accessories | LL60.EC.BK LL60.EC.WH LL60.EC.AL LL60.MB LL60.MC.ST LL60.MC.90° | led line 25 End Cap Black led line 25 End Cap White led line 25 End Cap Aluminium Mounting Bracket for recessed mounting Mechanical Connector plate Straight Mechanical Connector plate 90° |

oh!led NEW

Raising lighting to a new level. In the past OLED has mainly been used for decorative and ambient lighting. OLED stands for Organic LED and produces a natural glare-free light. This innovative OLED luminaire has a lumen output of 300lm from a single 12,7 cm sheet, which makes it the brightest commercially available OLED in the world and makes it perfectly suitable for functional lighting. This sleek panel, mainly made out of aluminium and glass is less than 5mm thick!

Design by Bart Lens





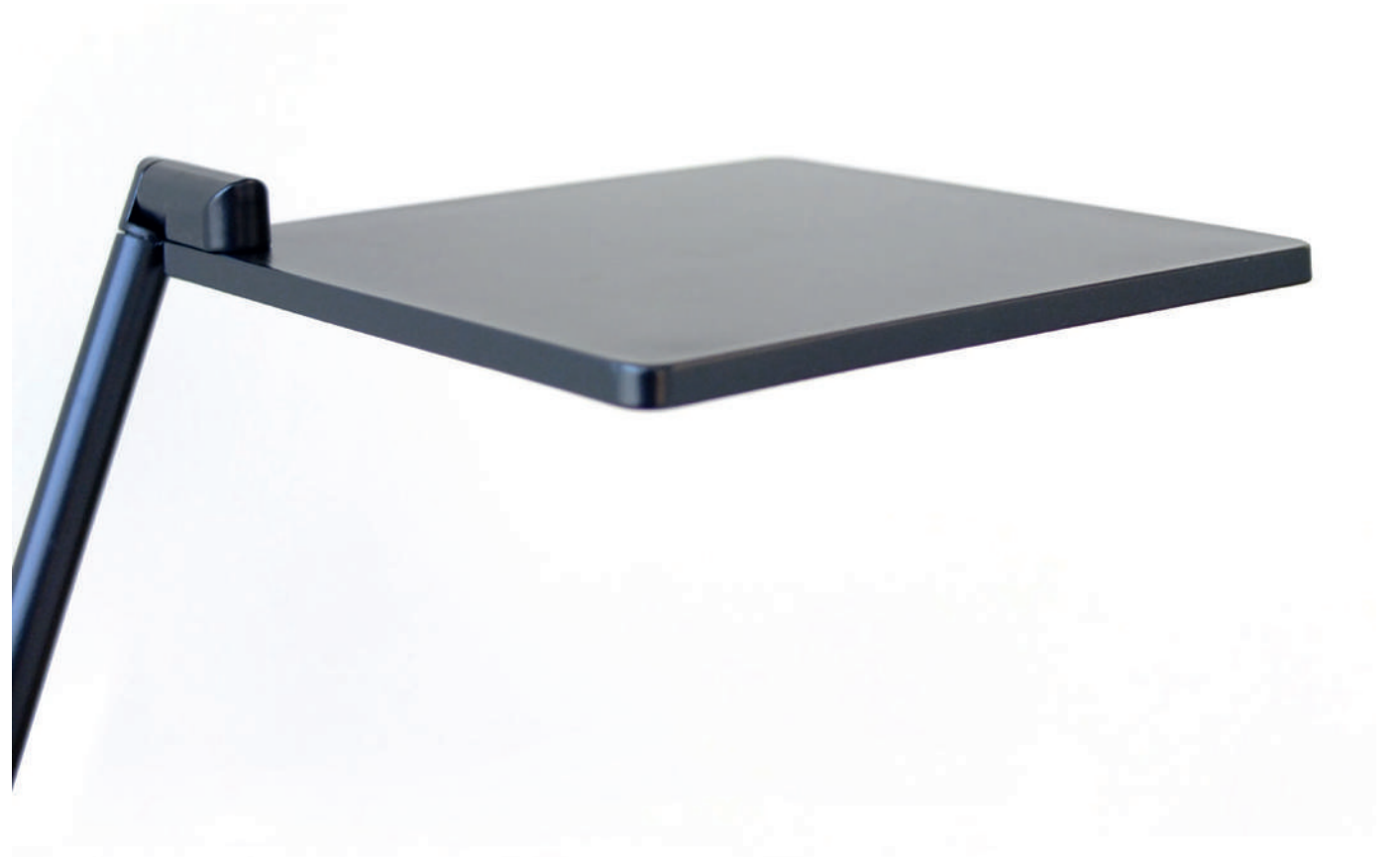
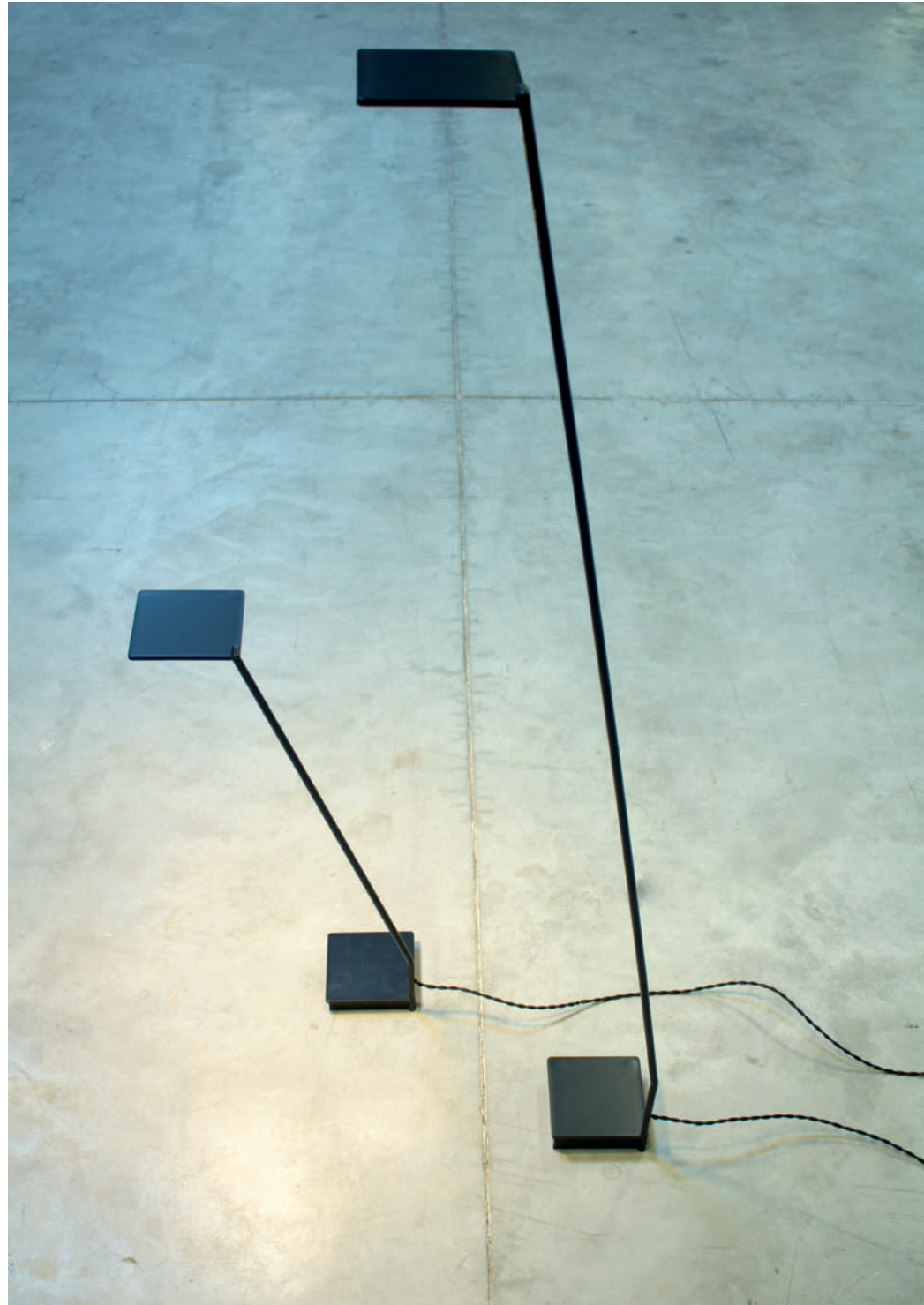

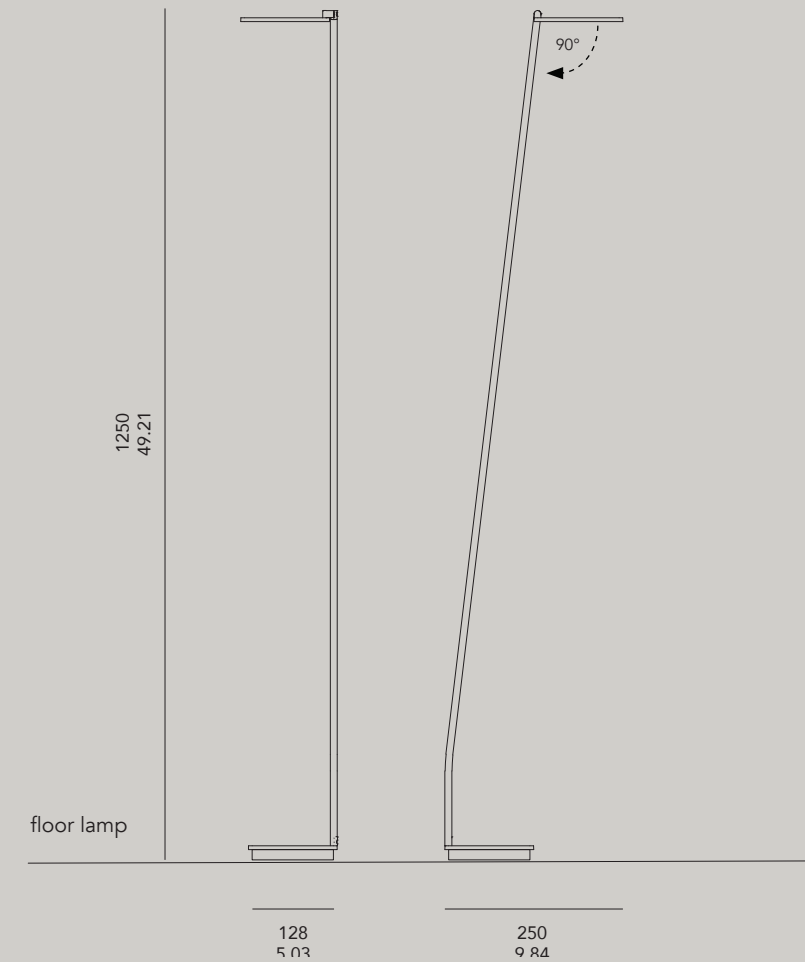
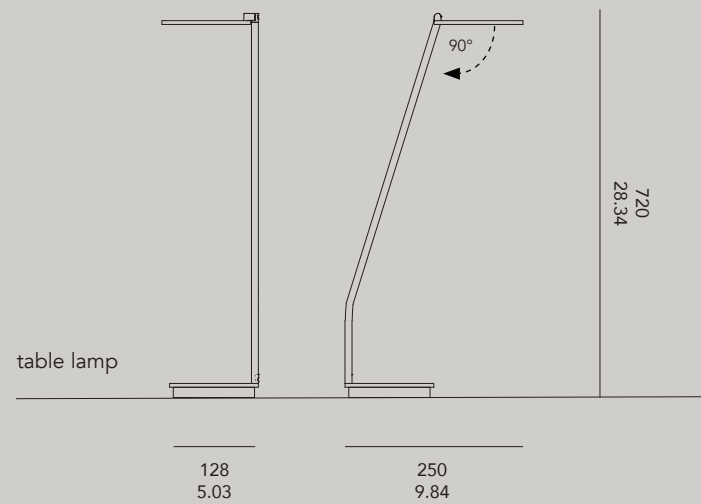
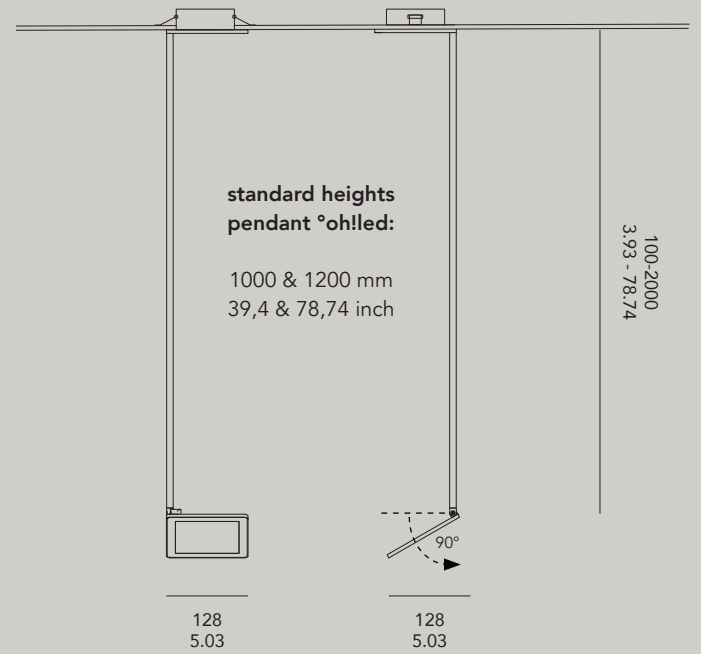

°oh!led

CE ENEC

- OH.WH.10V** pendant oh!led white (incl. ceiling rose), dimmable 1-10V
- OH.BK.10V** pendant oh!led black (incl. ceiling rose), dimmable 1-10V
- OH.WH.DAL** pendant oh!led white (incl. ceiling rose), dimmable DALI
- OH.BK.DAL** pendant oh!led black (incl. ceiling rose), dimmable DALI

standard length 1000 & 1200 mm / 39,4 & 78,74 inch
other lengths (from 100 to 2000 mm) on request

- OH.TA.WH** table lamp oh!led white
- OH.TA.BK** table lamp oh!led black

- OH.FL.WH** floor lamp oh!led white
- OH.FL.BK** floor lamp oh!led black

coated aluminium - 6,5W, 3000K, 300lm, 100-260VAC, IP20 - weight pendant 0,8kg-1,8lb / table 3,5kg-7,7lb / floor 4,6kg-10,1lb

°sphere

Belgian architect Bart Lens needed a large lamp that would create an encircling sphere of light above the conference table in their office, and so began the search. After a long and fruitless quest, he finally decided to design his own mega-light with the “sphere” of a dome. The result has been likened to a “Calimero” dome, a giant bell, a half moon.... Everybody seems to have a different name for it.

Design by Bart Lens





°sphere large / architect Lens°ass



°sphere large / office



°sphere large / House Roeselare, Belgium - architect Lens°ass - photograph by Bieke Claessens



°sphere large / "Rabbit Hole", Belgium - architect Lens°ass - photograph by Philippe van Gelooven



°sphere large / Concept Store Hasselt, Belgium - architect Lens°ass - photograph by Philippe van Gelooven



°sphere large / Indera upholstery - photograph by Decovan - Home-Art



°sphere large / Wagamama restaurant, Wembley, London



°sphere large / b&b moka & vanille, Heusden-Zolder - moka-projects



°sphere large / MRKT - Hirshleifers, NY, USA



°sphere large with imitation gold leaf / MRKT - Hirshleifers, NY, USA

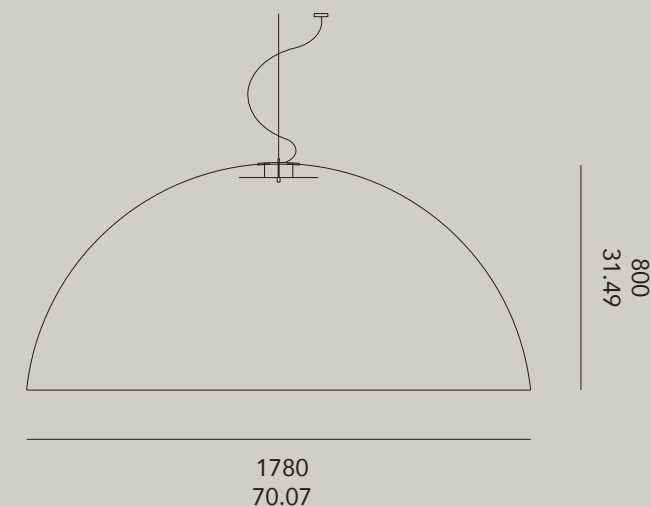

°sphere large 178



| | |
|------------------------|--|
| SPH.L.127.000 | 1 x E27 socket - excl lamp |
| SPH.L.227.000 | 2 x E27 socket - excl lamps |
| SPH.L.327.000 | 3 x E27 socket - excl lamps |
| SPH.L.427.000 | 4 x E27 socket - excl lamps |
| SPH.L.227.OPD | 2 x E27 socket with pull dimmer - excl. light bulbs |
| SPH.L.327.OPD | 3 x E27 socket with pull dimmer - excl. light bulbs |
| SPH.L.2200.000 | TL circuline 22W, 3000K |
| SPH.L.0040.000 | TL circuline 40W, 3000K |
| SPH.L.0055.000 | TL circuline 55W, 3000K |
| SPH.L.2240.000 | TL circ 22W + 40W, 3000K |
| SPH.L.2240.10V | TL circ 22W + 40W, dimmable 1-10V, 3000K |
| SPH.L.2240.DAL | TL circ 22W + 40W, dimmable DALI, 3000K |
| SPH.L.2255.000 | TL circ 22W + 55W, 3000K |
| SPH.L.2255.DAL | TL circ 22W + 55W, dimmable DALI, 3000K |
| SPH.L.2200.127 | TL circ 22W + 1 x E27 socket, 3000K |
| SPH.L.0040.127 | TL circ 40W + 1 x E27 socket, 3000K |
| SPH.L.2240.127 | TL circ 22W + 40W + 1 x E27 socket, 3000K |
| SPH.L.1LED.10V | 1 x LED module 3000lm cri90+, 37,5W, dimmable (1-10V)* |
| SPH.L.1LED.DAL | 1 x LED module 3000lm cri90+, 37,5W, dimmable (DALI)* |
| SPH.L.3LED.PHA | 3 x LED module 3750lm cri90+, 46,5W, dimmable (phase cut)* |
| SPH.L.3LED.10V | 3 x LED module 9000lm cri90+, 112,5W, dimmable(1-10V)* |
| SPH.L.3LED.DAL | 3 x LED module 9000lm cri90+, 112,5W, dimmable(DALI)* |
| SPH.L.LEDV2.DAL | 1 x LED disc 4000lm, 3000K |

*2700K Warm white, 3000K on request

PLX.SPH.50

coverplate diffuser plexi 50 cm Ø

material: ABS plastic, optional RAL colors / gold leaf both inside and out - weight: 25,5 kg / 899,48 oz
included : 2 m cable, ceiling rose and suspension - 230VAC - max 250W

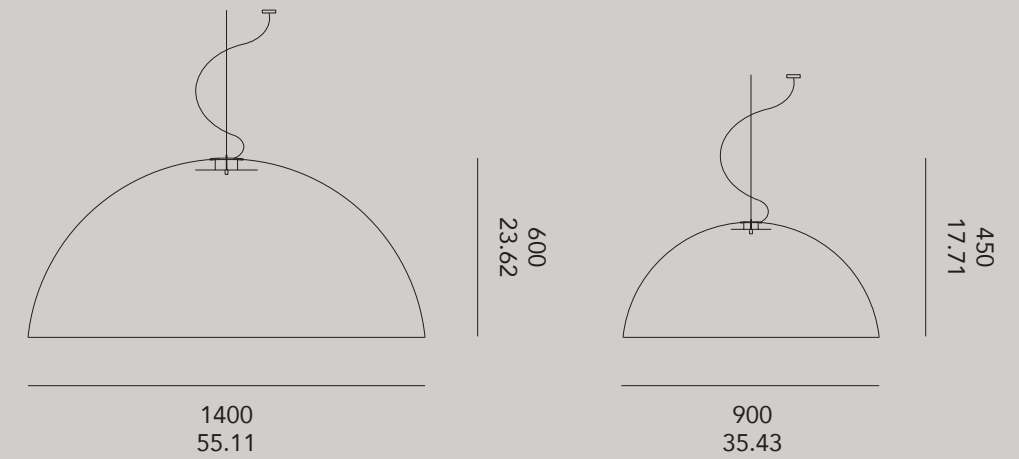

°sphere medium 140

°sphere small 90

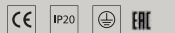

| | | |
|-----------------|----------------|---|
| SPH.M.127.000 | SPH.S.127.000 | 1 x E27 socket - excl lamp |
| SPH.M.227.000 | SPH.S.227.000 | 2 x E27 socket - excl lamps |
| SPH.M.327.000 | SPH.S.327.000 | 3 x E27 socket - excl lamps |
| SPH.M.427.000 | SPH.S.427.000 | 4 x E27 socket - excl lamps |
| SPH.M.227.0PD | SPH.S.227.0PD | 2 x E27 socket with pull dimmer - excl. light bulbs |
| SPH.M.327.0PD | SPH.S.327.0PD | 3 x E27 socket with pull dimmer - excl. light bulbs |
| SPH.M.2200.000 | SPH.S.2200.000 | TL circuline 22W |
| SPH.M.0040.000 | SPH.S.0040.000 | TL circuline 40W |
| SPH.M.0055.000 | SPH.S.0055.000 | TL circuline 55W |
| SPH.M.2240.000 | SPH.S.2240.000 | TL circ 22W + 40W |
| SPH.M.2240.10V | SPH.S.2240.10V | TL circ 22W + 40W, dimmable 1-10V |
| SPH.M.2240.DAL | SPH.S.2240.DAL | TL circ 22W + 40W, dimmable DALI |
| SPH.M.2255.000 | - | TL circ 22W + 55W |
| SPH.M.2255.DAL | - | TL circ 22W + 55W, dimmable DALI |
| SPH.M.2200.127 | SPH.S.2200.127 | TL circ 22W + 1 x E27 socket |
| SPH.M.0040.127 | SPH.S.0040.127 | TL circ 40W + 1 x E27 socket |
| SPH.M.2240.127 | SPH.S.2240.127 | TL circ 22W + 40W + 1 x E27 socket |
| SPH.M.1LED.PHA | SPH.S.1LED.PHA | 1 x LED module 1250lm cri90+, 15,5W, dimmable (phase cut) 2700K warm white* |
| SPH.M.1LED.10V | - | 1 x LED module 3000lm cri90+, 37,5W, 2700K warm white*, dimmable (1-10V) |
| SPH.M.1LED.DAL | - | " dimmable (DALI) |
| SPH.M.3LED.PHA | - | 3 x LED module 3750lm cri90+, 46,5W, Dimmable (phase cut) 2700K warm white* |
| SPH.M.3LED.10V | - | 3 x LED module 9000lm cri90+, 112,5W, 2700K warm white*, dimmable (1-10V) |
| SPH.M.3LED.DAL | - | " dimmable (DALI) |
| SPH.M.LEDV2.DAL | - | 1 x LED disc 4000lm + coverplate, 3000K |
| | | *3000K on request |
| PLX.SPH.35 | | coverplate plexi 35 cm Ø |
| PLX.SPH.50 | | coverplate plexi 50 cm Ø |

material: ABS plastic, optional RAL colors / gold leaf both inside and out - weight M: 13,5 kg - 476 oz - weight S: 5 kg - 176 oz
included: 2 m cable, ceiling rose and suspension - 230VAC - sphere small: max 100W - sphere medium: max 150W

lightsources for °sphere

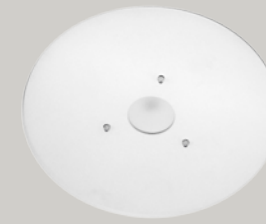
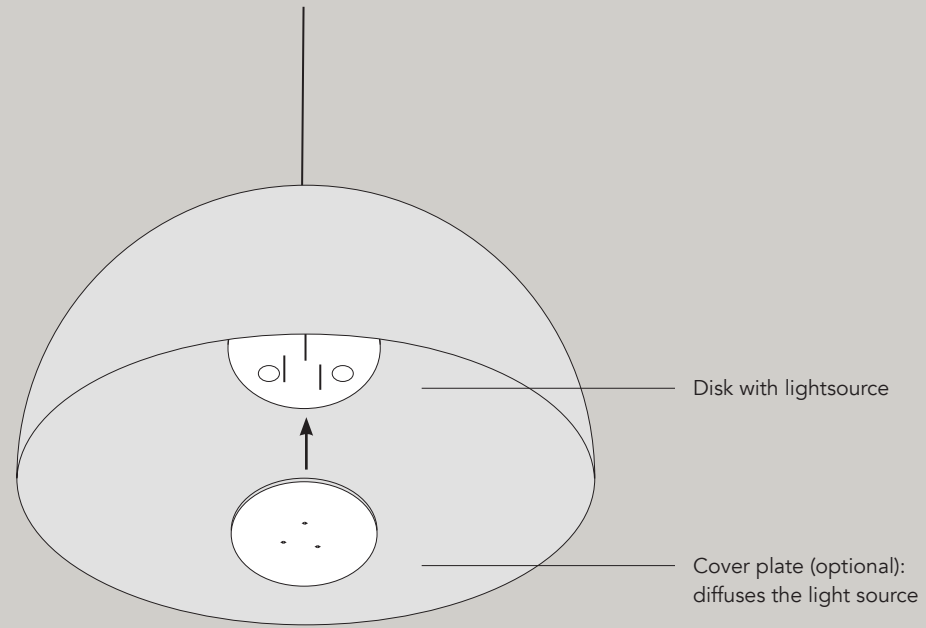

1 x LED module (diam. 300mm)



1 x LED disc (diam. 315mm)
with coverplate 350mm (incl.)
(equal light source)

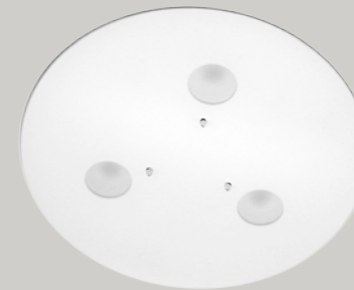

3 x LED module (diam. 400mm)



2 x TL circuline (diam. 300mm)
excl. light bulbs



1 x socket E27 (diam. 150mm)
excl. light bulbs



3 x socket E27 (diam. 300mm)
excl. light bulbs

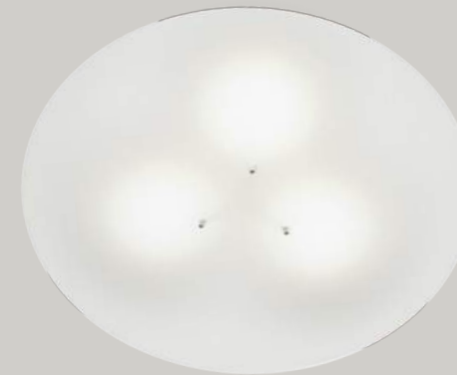

3 x LED module (diam. 400mm) or
3 x E27 (diam. 300mm)
with cover plate 500mm

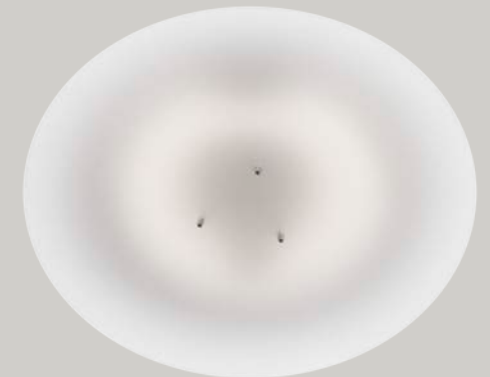

2 x TL circuline (diam. 300mm)
with coverplate 500mm

°led on fire

In a T-restaurant in Peking (China), Mr. Lens was eating at an immense mirror table with candles hanging above him. It was cozy, romantic, but also streamlined and modern. For another design we already experimented with hanging led-lights suspended from low charged wires. We marveled at the vision of a completely accidental, out-of-the box combination of a led underneath a burning candle. The effect of the translucent candle-emulsion was also heartwarming. The apparition of a led fixture, burning, not at all kitschy, with light shimmering through the material structure is imprinted in our minds. “The led is on fire”, we tried it out.

Design by Bart Lens





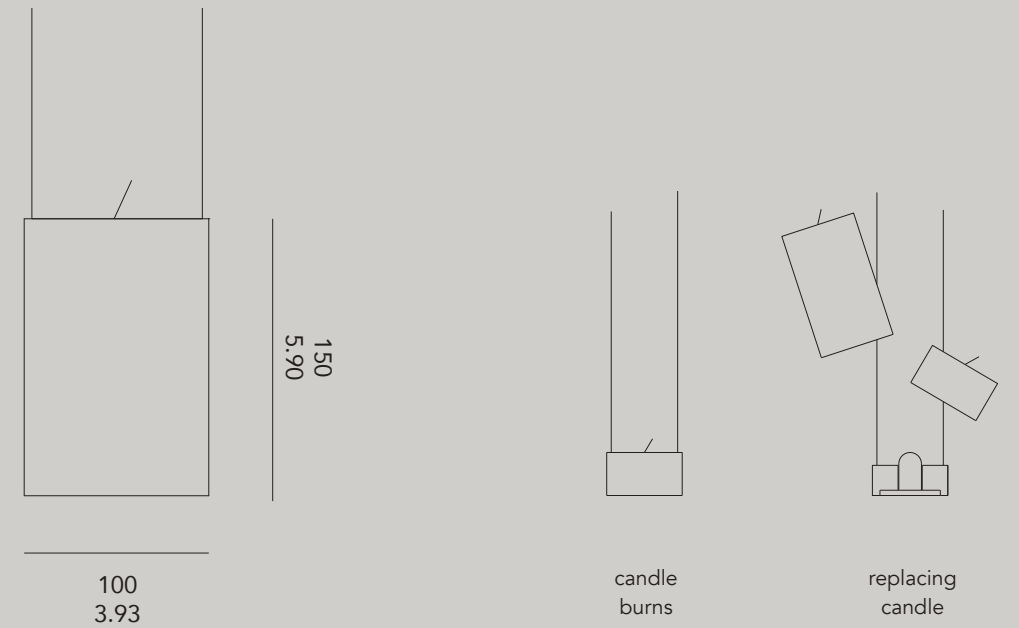

°led on fire

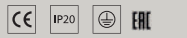

LOF

led on fire, 2700K

Accessories

LOF.ROS.T

ceiling rose round Trimless

LOF.ROS.R

ceiling rose round Recessed

LOF.ROS.S

ceiling rose round Surface mount, single piece

LOF.ROS.S3

ceiling rose rectangle Surface mount, three pieces

LOF.RC

replacement wax candle

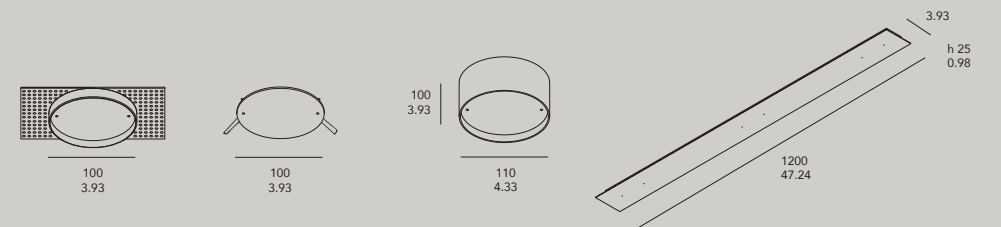

materials: aluminium, glass, wax candle - weight: 1,2 kg / 42,3 oz - indoor use - 230VAC - max. 4W

included: 2m cables and LED driver 1-10V or Dali dimmable (on request)

°fool moon

People have always been fascinated by the light of a perfect circle. The returning full moon and the natural phenomena ascribed to it (higher childbirth percentage, fertility, transformation from human to animal, etc.), the archetypical form of a UFO, the shape of a gong, the sun... are but a few striking examples. Despite its shape of a full circle ('full moon'), the lamp can be used in several positions: horizontally, diagonally, obliquely or vertically ('fool moon'). Thanks to its large dimensions, the lamp is easily recognisable and has the possibility of demarcating or creating spaces. The lamp also has a highly symbolic value due to its imposed abstraction.

Design by Bart Lens







°fool moon wall 1 / Mendeli Street Hotel, Tel-Aviv - ST-OR - lighting designer Ailon Gavish, Studio Twilight - photograph by Omri Amsalem



°fool moon wall 1 / Christian Puglisi's restaurant BÆST, Copenhagen - architect Fobsi Studio

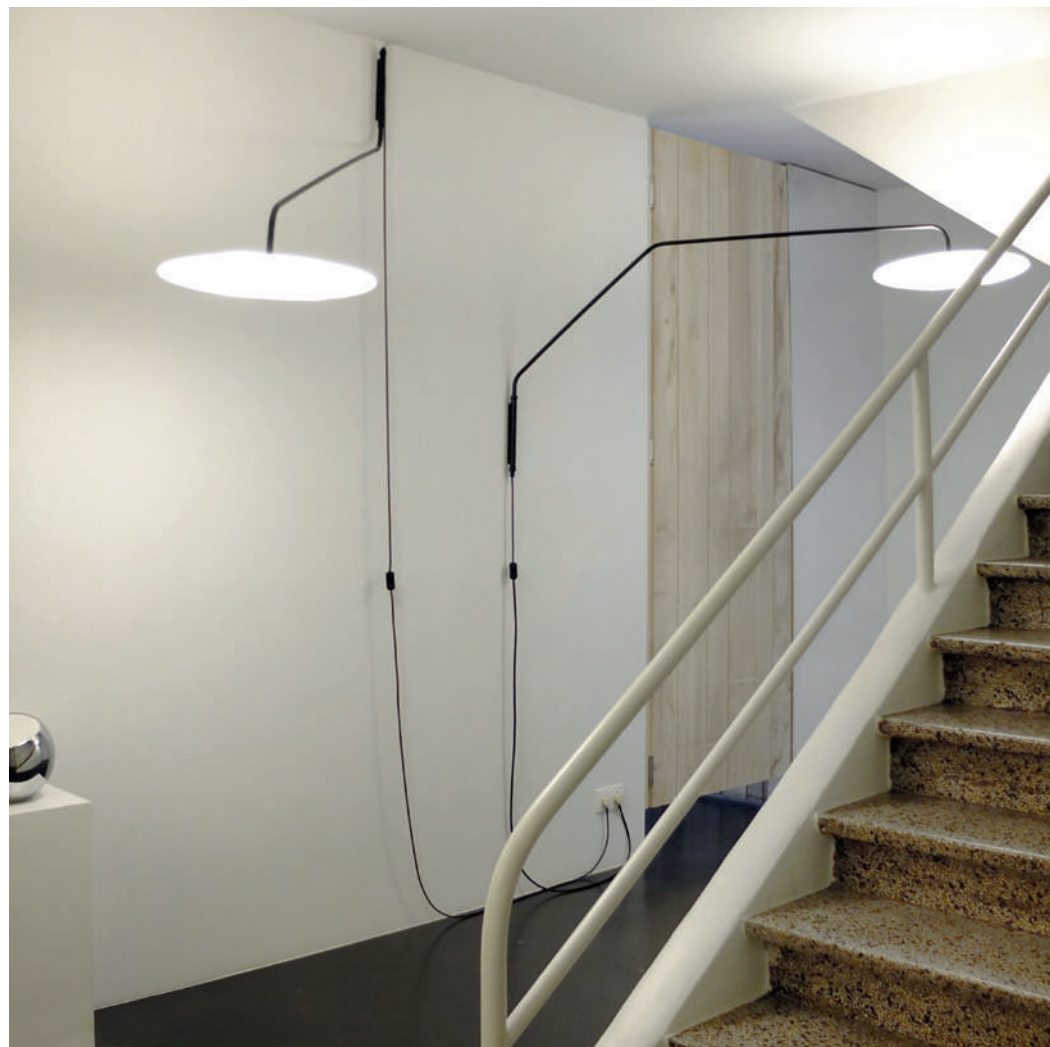

°fool moon wall 1 & 2 / Office hall, Hasselt - architect Lens°ass



°fool moon wall 2 / Depoortere, Hasselt - architect Lens°ass - photograph by Bieke Claessens





°fool moon medium / Maison Bettant, Paris - architect Mona LISA - Christophe Millet - photograph by Five 5 Star - light design Inédit



°fool moon small / Villa Brockmans - D&A Architecten - photograph by Natuursteenbedrijf Tuytelaers

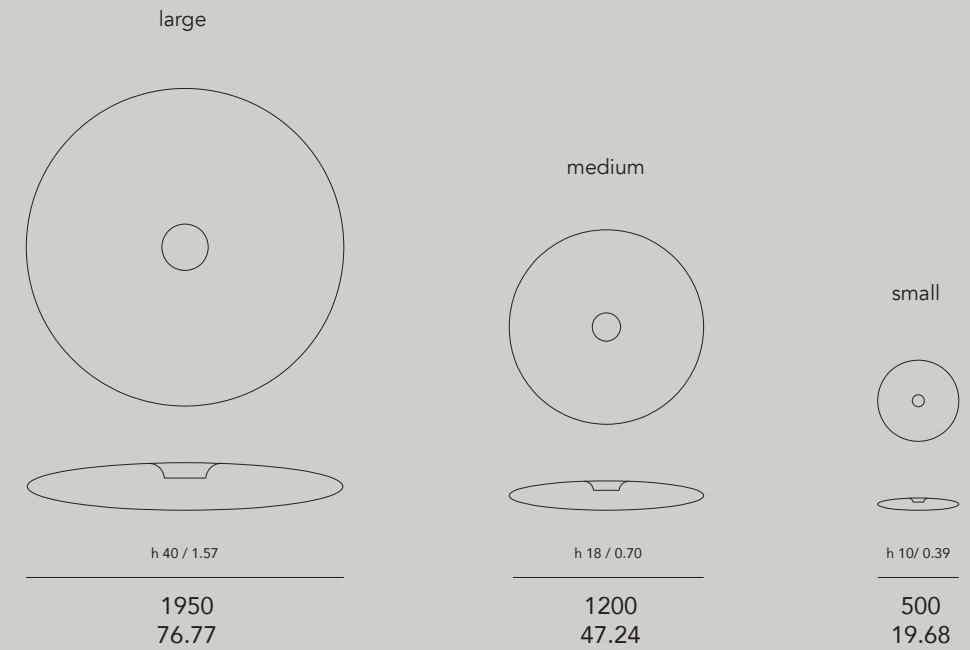

°fool moon large

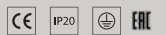

| | |
|-------------------------|---|
| FM.L.355.000 | 3 x PL 55W, 3000K |
| FM.L.355.10V | 3 x PL 55W dimmable 1-10V, 3000K |
| FM.L.355.DAL | 3 x PL 55W dimmable DALI, 3000K |
| FM.L.355.RGB.DMX | 3 x PL 55W + RGB LED - DMX controllable |
| FM.L.355.RGB.DAL | 3 x PL 55W + RGB LED - DALI controllable |
| FM.L.355.RGB.M | 3 x PL 55W + RGB LED - master with remote control |
| FM.L.355.RGB.S | 3 x PL 55W + RGB LED - slave (master required) |

°fool moon medium



| | |
|-------------------------|--------------------------------------|
| FM.M.324.000 | 3 x PL 24W, 3000K |
| FM.M.324.10V | 3 x PL 24W dimmable 1-10V, 3000K |
| FM.M.000.RGB.DMX | RGB LED DMX controllable |
| FM.M.000.RGB.DAL | RGB LED DALI controllable |
| FM.M.000.RGB.M | RGB LED - master with remote control |
| FM.M.000.RGB.S | RGB LED - slave (master required) |

°fool moon small



| | |
|----------------------|---|
| FM.S.3LED.000 | 3 x led 5W, E14 socket, phase-cut dimmable, 2700K |
| FM.S.RGB.DMX | RGB LED DMX controllable, driver remote (in ceiling) |
| FM.S.RGB.DAL | RGB LED DALI controllable, driver remote (in ceiling) |
| FM.S.RGB.M | RGB LED - master with remote control |
| FM.S.RGB.S | RGB LED - slave (master required) |

material: PE - weight L: 33 kg - 1164 oz - weight M: 20 kg - 705 oz - weight S: 3 kg - 105 oz

FM large max. 200W - FM medium max. 72W - FM small max. 15W - 230VAC

included: 2 m cable, ceiling rose and suspension elements

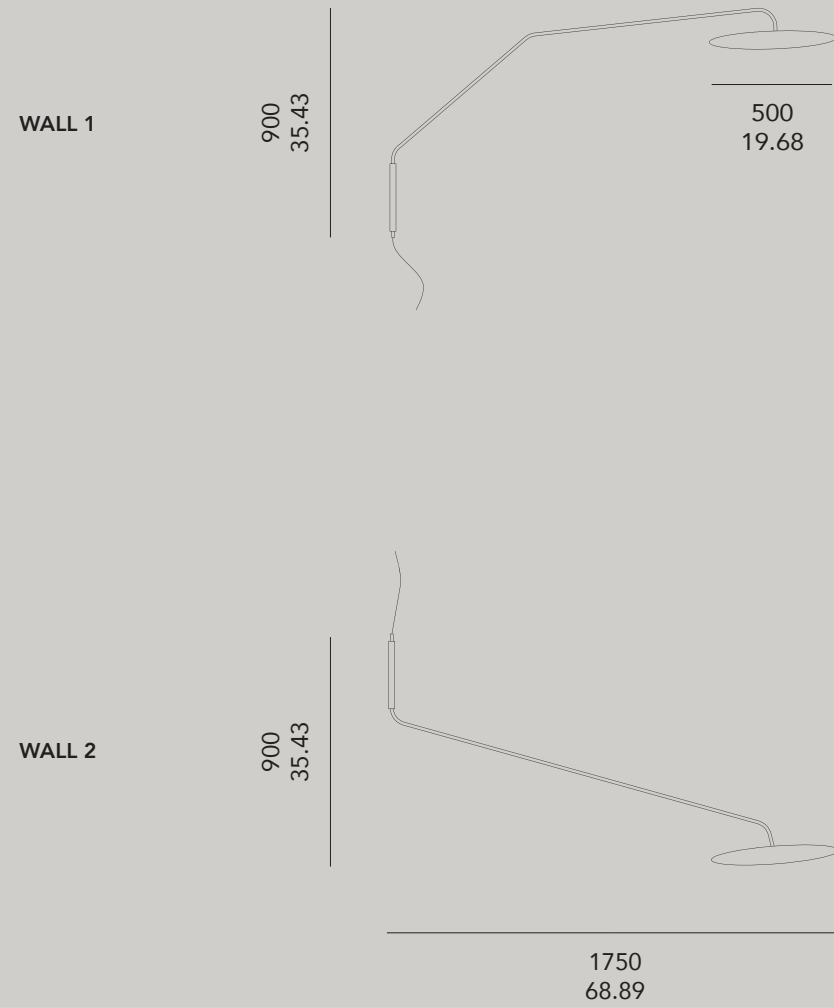

°fool moon wall type



| | |
|------------------------|---|
| FM.S.3LED.WALL1 | 3 x led 5W, E14 socket, phase-cut dimmable, 2700K |
| FM.S.3LED.WALL2 | 3 x led 5W, E14 socket, phase-cut dimmable, 2700K |

materials: PE & steel - weight: 4,5 kg / 158 oz - 230VAC - max. 15W

°LEDit-bi

LEDit-Bi is a wall lamp shining in two directions (Bi-directional). The shade is built up out of two materials (Bi-material cover). The aluminium profile holds a foil that in its material and color can be adapted to your interior and style. As well with the light as with the design of the shade, an accent is set. The here used light sources are standard available bulbs. Any replacement is easy and assured.

Design by Stan Maes

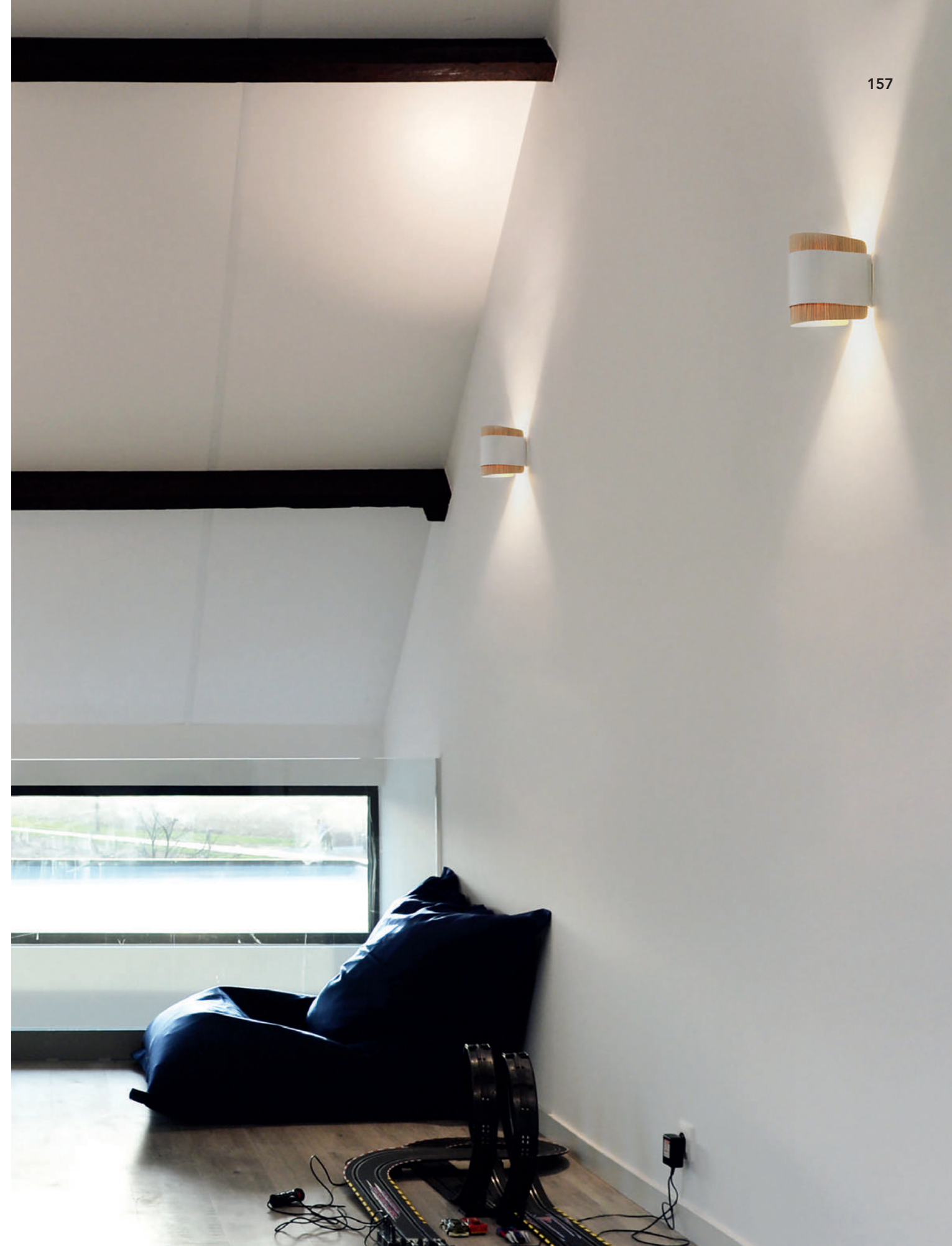



°LEDit-Bi high, white, oak diffuser



°LEDit-Bi low, white, oak diffuser



°LEDit-Bi high, black, oak diffuser



°LEDit-Bi low, white, blue PP diffuser



°LEDit-Bi high, black, brushed brass diffuser

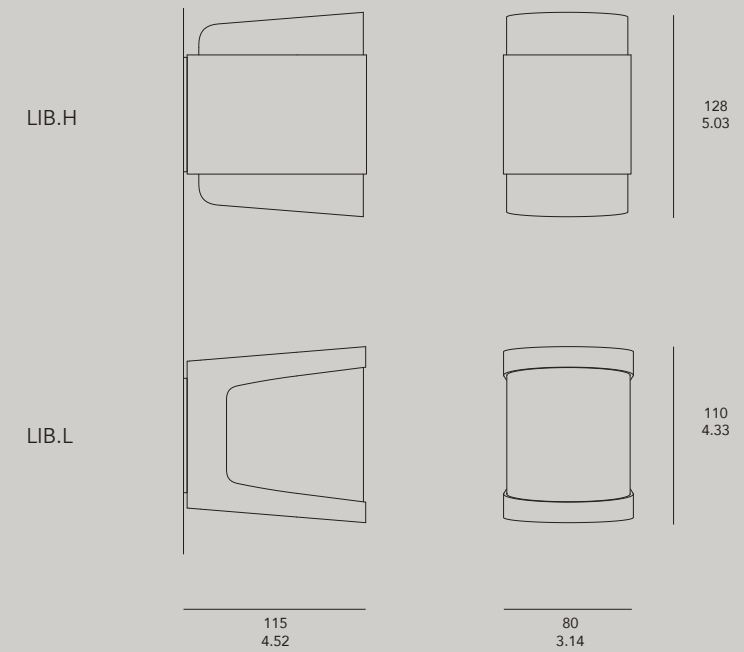

| | | | |
|------------|--|--|---------|
| LIB.H.C.D | | GU9 fitting | CE IP20 |
| Color body | BK WH | black matt ral 9011 white matt ral 9016 | |
| Diffuser | BRA.BR BRA.HP OAK WAL CUS | brass brushed brass high polish oak veneer walnut veneer custom digital print on opal polypropylene (PP) sheet | |
| LIB.L.C.D | | GU9 fitting | CE IP20 |
| Color body | BK WH | black matt ral 9011 white matt ral 9016 | |
| Diffuser | BRA.BR BRA.HP OAK WAL CUS | brass brushed brass high polish oak veneer walnut veneer custom digital print on opal polypropylene (PP) sheet | |

°XXXL(amp)

Perhaps symptomatic of an architect's mindset, the lamps and objects are becoming increasingly 'space defining'. The xxxl(amp) is essentially a flattened dome, inspired by the shape of a Chinese lantern. The twelve-segment construction makes the connection with the lantern, but a pumpkin is perhaps the first association that comes to mind, while the suspension system recalls an upside-down hot-air balloon. If the ceiling is high, but not overly high, the lamp can be hung at about 1.50m. As befits any impressive space, you'll want to enter with a slight bow. Once seated at the dining or conference table, you'll still retain a sense of the surroundings beyond the boundary. Hanging a half or a quarter xxxl(amp) in a mirrored room creates an impression of spacious rooms full of giant lanterns.

Design by Bart Lens







Belgian TV-show 'Volt'



C Chocolat, Brest - architect Trace & Associes - photograph by Pierre-Jean Verger





Maison Bettant, Paris - architect Mona LISA - Christophe Millet - photograph by Five 5 Star - lightdesign Inédit

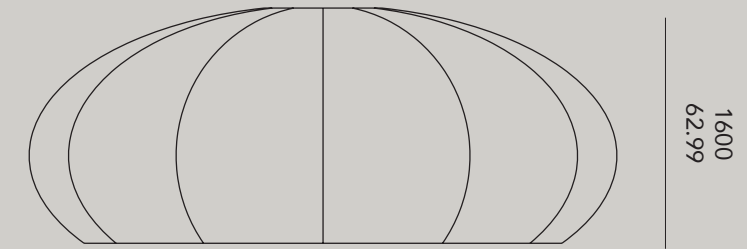

3250
127.95

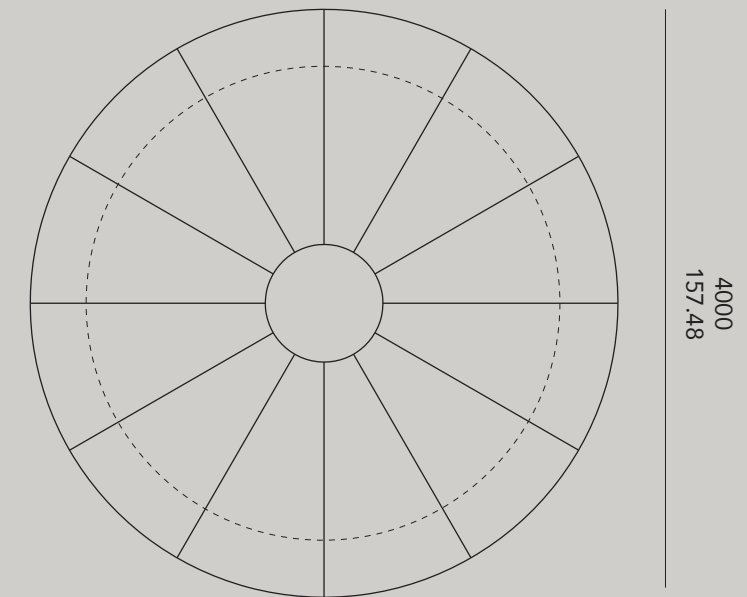

°XXXL(amp)

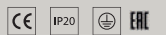

| | |
|-------------------------|--|
| XXXL.927.000 | XXXL(amp) standard 9 x E27 - excl. lamps |
| XXXL.927.RGB.M | XXXL(amp) 9 x E27 socket + RGB LED master + remote control |
| XXXL.927.RGB.S | XXXL(amp) 9 x E27 socket + RGB LED slave |
| XXXL.927.RGB.DMX | XXXL(amp) 9 x E27 socket + RGB LED DMX controllable |
| XXXL.927.RGB.DAL | XXXL(amp) 9 x E27 socket + RGB LED DALI controllable |

material: PE - weight: 355 kg / 12.525 oz - 230VAC - max 1500W

included: 4 m / 155 in cables & 12 suspension elements, lighting element with 2 m / 78 in suspension bar

°diabolo

Two hemispheres, a couple or twins, of which one of them is lighted by LED and rotates 190° / 360° on its axis. Single or in line, it evokes images of a solar eclipse, a chesterfield chair or a diabolo toy. Available as table-lamp, wall lamp or ceiling lamp and in several colors.

Design by Bart Lens



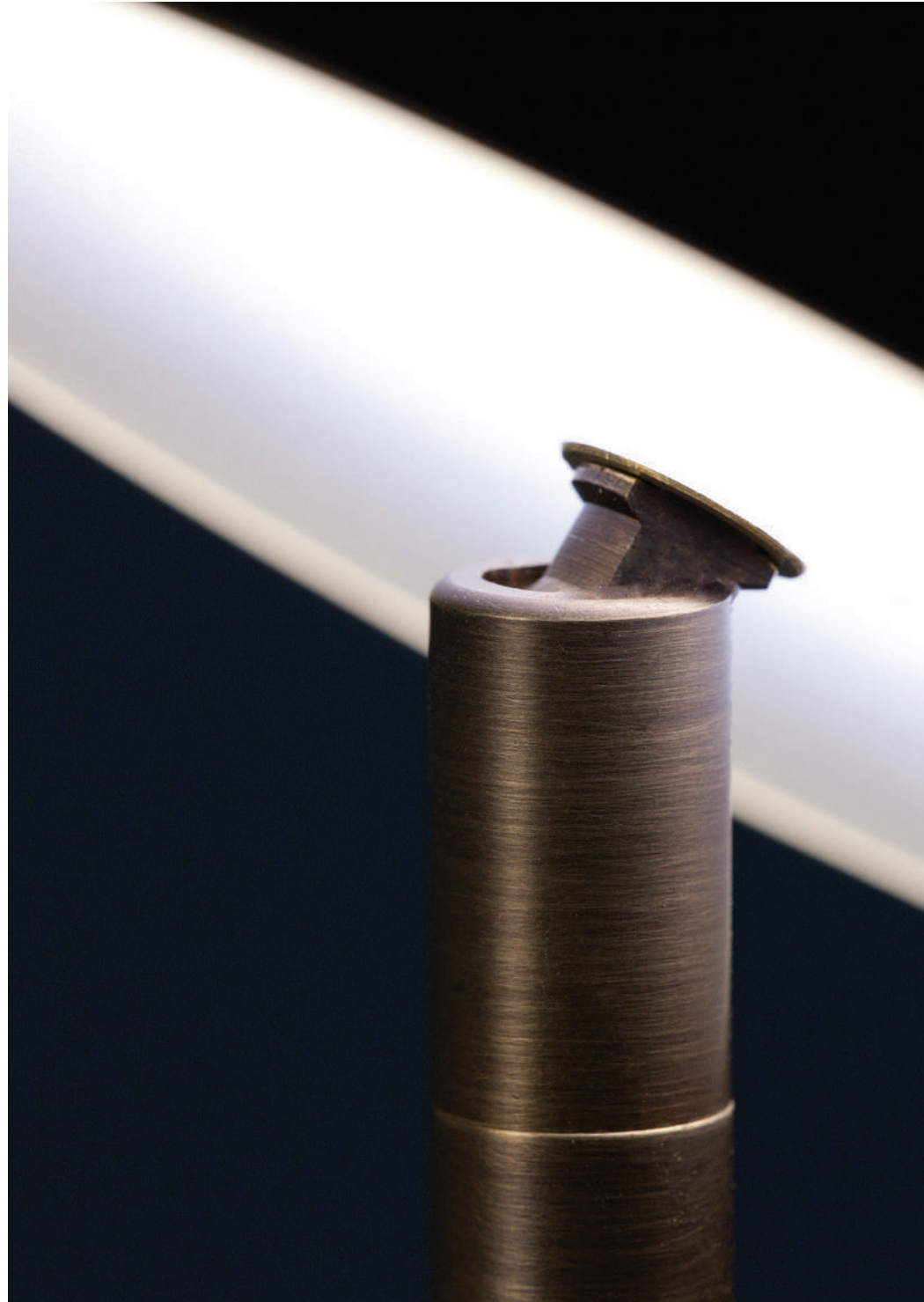

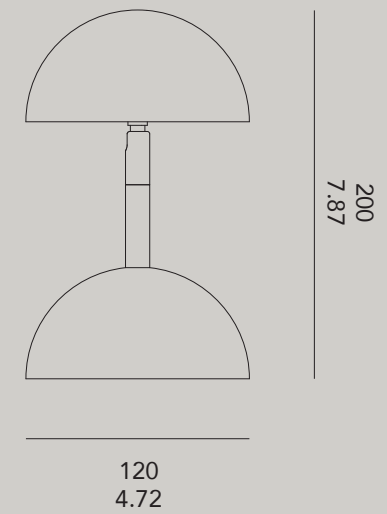

°diabolo

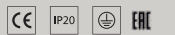

| | |
|-----------------------|--|
| DBL.WH.30 | white - 3000K LED |
| DBL.BK.30 | black - 3000K LED |
| DBL.BRZ.30 | bronze - 3000K LED |
| DBL.BRS.30 | brass - 3000K LED |
| DBL.RAL.30 | other RAL colors - 3000K LED |
| DBL.TBL.WH.30 | table model - white - 3000K LED |
| DBL.TBL.BK.30 | table model - black - 3000K LED |
| DBL.TBL.BRZ.30 | table model - bronze - 3000K LED |
| DBL.TBL.BRS.30 | table model - brass - 3000K LED |
| DBL.TBL.RAL.30 | table model - other RAL colors - 3000K LED |
| DBL.WH.27 | white - 2700K LED |
| DBL.BK.27 | black - 2700K LED |
| DBL.BRZ.27 | bronze - 2700K LED |
| DBL.BRS.27 | brass - 2700K LED |
| DBL.RAL.27 | other RAL colors - 2700K LED |
| DBL.TBL.WH.27 | table model - white - 2700K LED |
| DBL.TBL.BK.27 | table model - black - 2700K LED |
| DBL.TBL.BRZ.27 | table model - bronze - 2700K LED |
| DBL.TBL.BRS.27 | table model - brass - 2700K LED |
| DBL.TBL.RAL.27 | table model - other RAL colors - 2700K LED |

material: painted aluminium - weight: 1,2 kg / 42,3 oz - 230VAC - 5W - dimmable 1-10V

°xl(amp)

This lamp was initially designed to mark the edge of a fair booth and simultaneously present images on the inside. The lamp shade foil is foldable. This allows for easy transport and makes it possible to cover the lamp with a photo film. The lamp, by virtue of its size, defines its own space.

Design by Bart Lens







Foyer Universum Bremen



Office Nulens, Belgium - architect Lens°ass - photograph by Philippe van Gelooven





Kitchen concept Obumex - architect Lens°ass

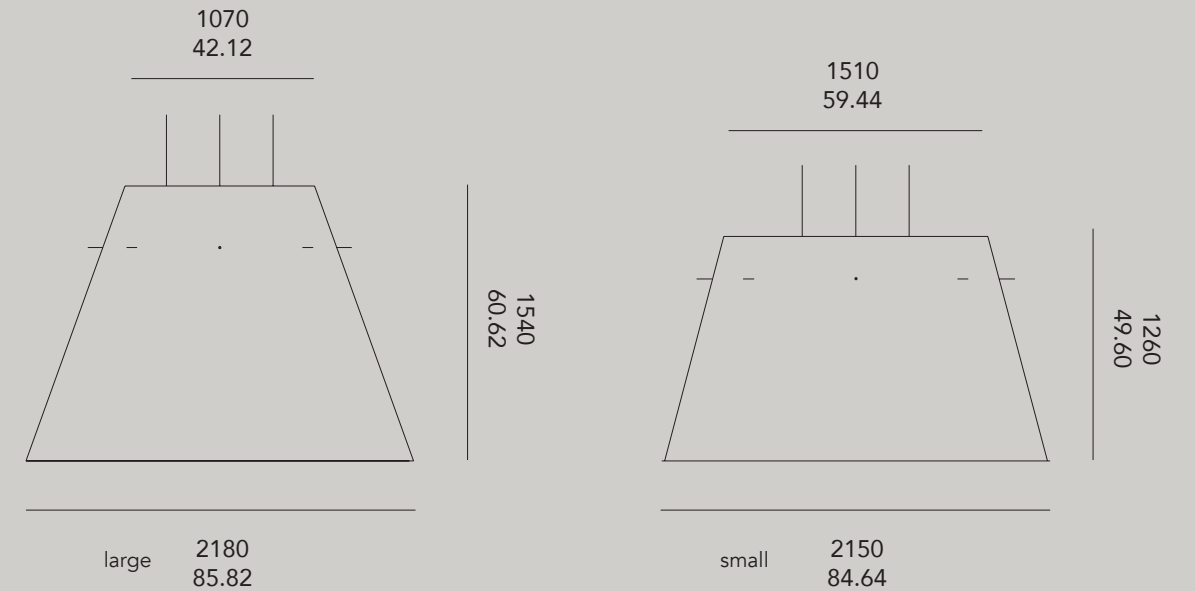

°xl(amp) large

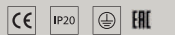

| | |
|-----------------------|---|
| XL.154.000 | Xlamp h154 - 1 x E27 - excl lamp |
| XL.154.RGB.M | Xlamp h154 - 1 x E27 socket + RGB LED Master with remote control - excl lamp |
| XL.154.RGB.S | Xlamp h154 - 1 x E27 socket + RGB LED slave - excl lamp |
| XL.154.RGB.DMX | Xlamp h154 - 1 x E27 socket + RGB LED DMX controllable - excl lamp |
| XL.154.RGB.DAL | Xlamp h154 - 1 x E27 socket + RGB LED DALI controllable - excl lamp |

°xl(amp) small

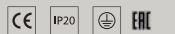

| | |
|-----------------------|---|
| XL.126.000 | Xlamp h126 - 1 x E27 - excl lamp |
| XL.126.RGB.M | Xlamp h126 - 1 x E27 socket + RGB LED Master with remote control - excl lamp |
| XL.126.RGB.S | Xlamp h126 - 1 x E27 socket + RGB LED slave - excl lamp |
| XL.126.RGB.DMX | Xlamp h126 - 1 x E27 socket + RGB LED DMX controllable - excl lamp |
| XL.126.RGB.DAL | Xlamp h126 - 1 x E27 socket + RGB LED DALI controllable - excl lamp |

material: polyester - weight: max 34kg / 1.200oz - included: 2m cable, ceiling rose, 3 suspension elements - 230VAC - max 1000W

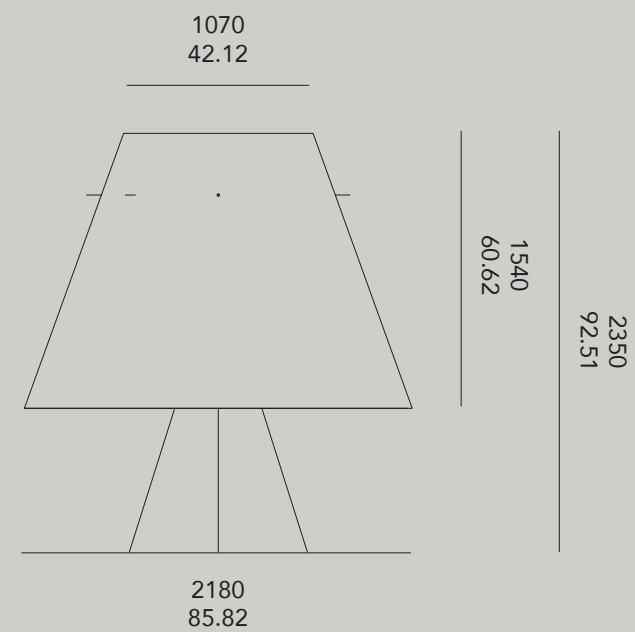

°xl(amp) floor



XL.154.127.FLR

1xE27 socket floor - excl lamp

material: polyester & steel - weight 36 kg / 1270 oz - included: 2m cable - 230VAC - max 1000W

°i-light

i-light is a thin, hanging tubular light fixture with an incorporated LED-light. The small loose-hanging chrome-plated sphere creates an unusual light and shadow play. The lamp can be used as trim lights, hanging lights, or – when several are combined – as a chandelier. When the tubes are hung low, the reflection of the chrome-plated rods produces a ‘starry sky effect’.

Design by Bart Lens



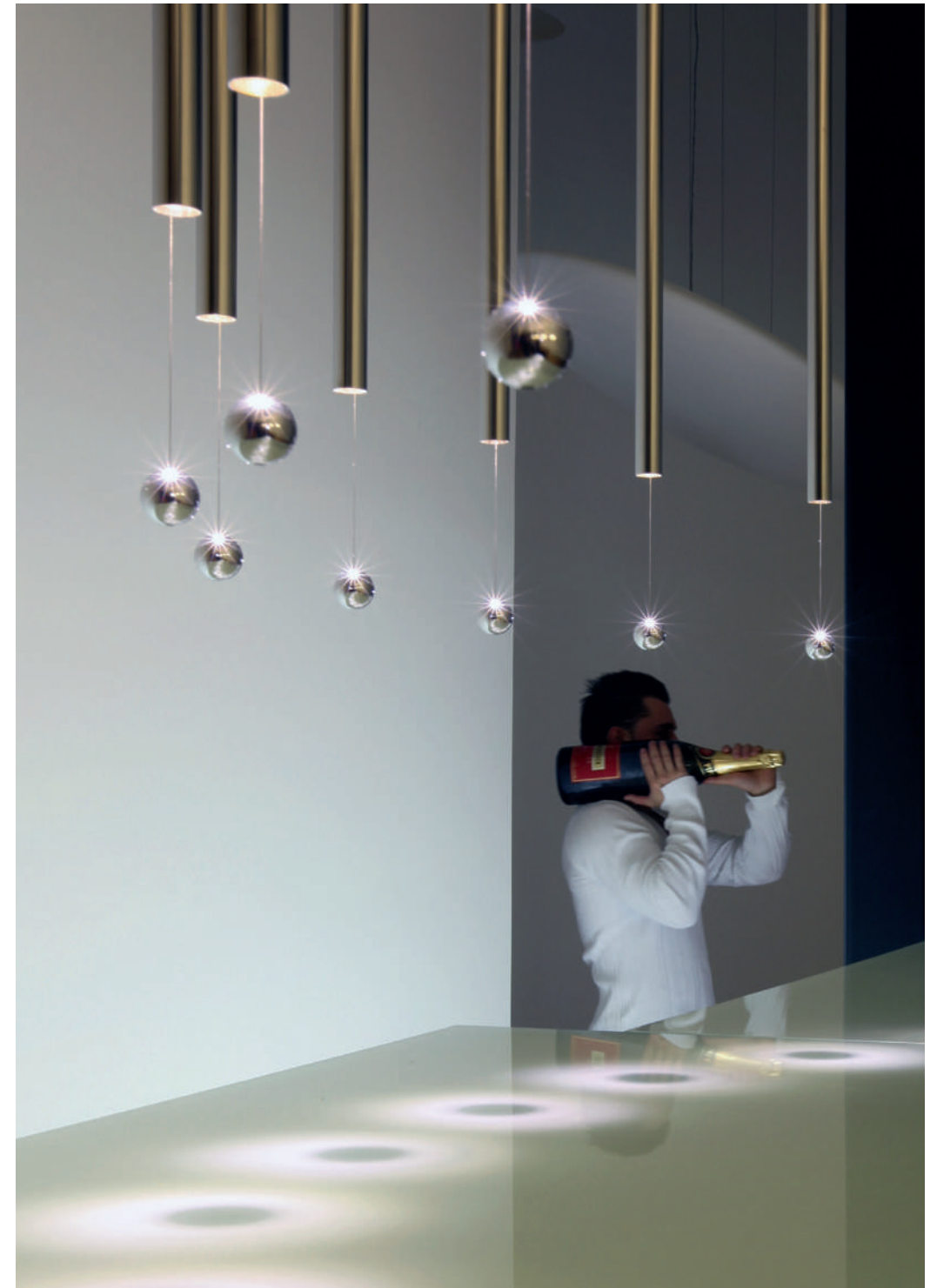



°i-light



IL

i-light, 2700K

material: chromed brass - weight: 1,4 kg / 50 oz - included: 2 m cable & ceiling rose - 24VDC - max. 2W - excl. power supply

°tablecloth

A synthetic drape forms a covered table and at the same time a table structure. Entirely resembling a starched hail blank tablecloth, but manufactured in self-supporting blank plastic. Optionally, rechargeable light modules are available so that the tables can be placed wireless everywhere. After seven hours the tables announce the end of the party. Time to recharge!

Design by Bart Lens







600
23.62



1100
43.30

600
23.62

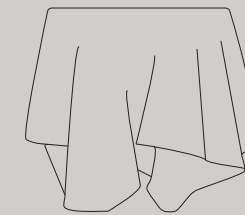

670
26.37

low

°tablecloth

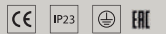

| | |
|--------------------|---|
| TCL.000 | tablecloth |
| TCL.127 | tablecloth 1 x E27 socket + 2 m cable - excl lamp |
| TCL.LED.B | tablecloth with white LEDs + battery-charger |
| TCL.RGB.B | tablecloth with RGB LEDs + battery-charger + remote control |
| TCL.RGB.C | tablecloth with RGB LEDs + cable + remote control |
| TCL.RGB.DMX | tablecloth with RGB LEDs, DMX controllable |
| TCL.TR.000 | tablecloth transparant |

°tablecloth low

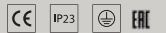

| | |
|----------------------|---|
| TCL.L.000 | tablecloth low |
| TCL.L.127 | tablecloth low 1 x E27 socket + 2m cable - excl lamp |
| TCL.L.LED.B | tablecloth low with white LEDs + battery-charger |
| TCL.L.RGB.B | tablecloth low with RGB LEDs + battery-charger + remote control |
| TCL.L.RGB.C | tablecloth low with RGB LEDs + cable + remote control |
| TCL.L.RGB.DMX | tablecloth low with RGB LEDs, DMX controllable |
| TCL.L.TR.000 | tablecloth low transparant |

material: PMMA - weight: 23,5 kg / 811 oz - 230VAC - max. 100W

°so1

The design of this large-scaled lamp is pure and back to basic, therefore the SO1 really leaves nobody untouched. Made in PE (polyethylene) by rotational moulding, this large lamp (height 1m40) can be used inside as well as outside.

Built-in into ceiling or wall, lying on the floor or just hanging in the room. Outside used as street light (with a post) or as lighting accent in the garden.

The use of this lighting-object will give an extra accent to rooms, spaces, streets and public parks.

Design by Sara Olaerts



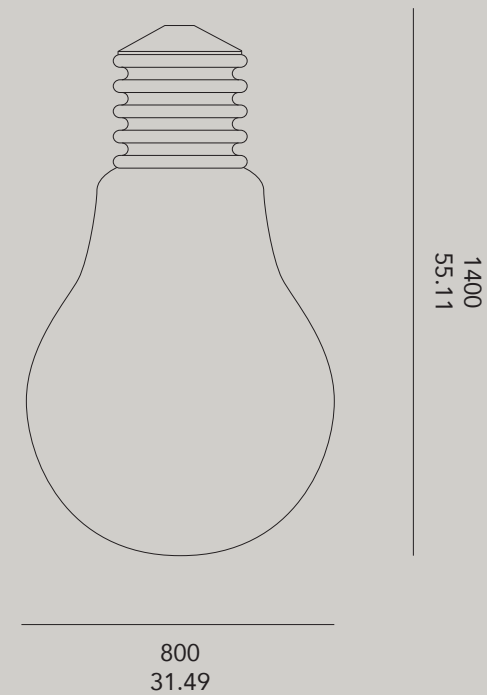

°so1



| | |
|--------------------|---|
| SO1.155.000 | SO 1 - 1 x PL55W |
| SO1.155.US | SO 1 - 1 x PL55W - 110VAC |
| SO1.155.DAL | SO 1 - 1 x PL55W DALI controllable |
| SO1.RGB.DMX | SO 1 RGB LED DMX controllable |
| SO1.RGB.DAL | SO 1 RGB LED DALI controllable |
| SO1.RGB.M | SO 1 RGB LED master with remote control |
| SO1.RGB.S | SO 1 RGB LED slave |

materials: PE & steel - weight: 18kg / 635oz - 230VAC or 110VAC - max 55W

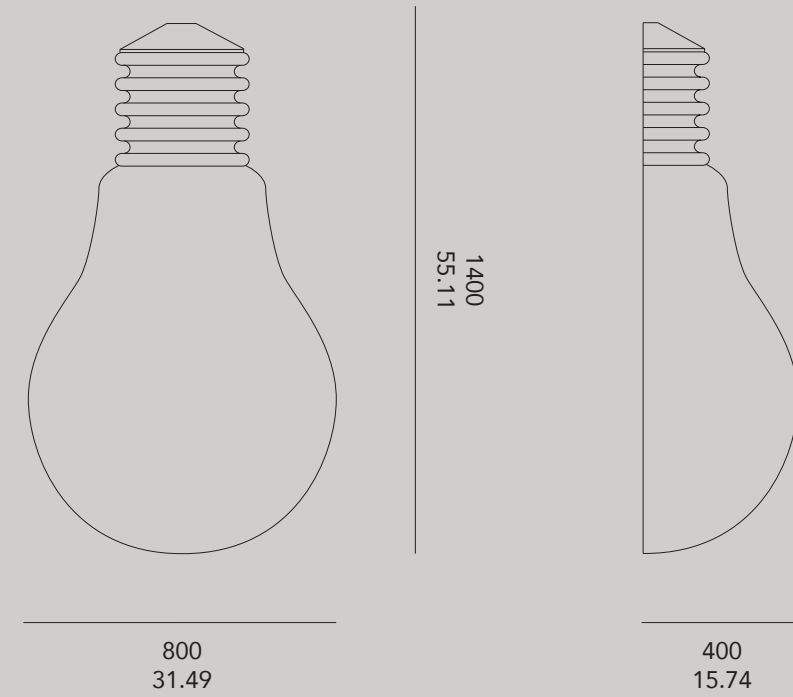

°1/2 so1

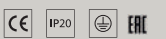

| | |
|------------------------|---|
| SO1.155.1/2 | 1/2 SO 1 with 1 x PL55W |
| SO1.155.1/2.US | 1/2 SO 1 with 1 x PL55W - 110VAC |
| SO1.155.1/2.DAL | 1/2 SO 1 with 1 x PL55W DALI controllable |

materials: PE & steel - weight: 10kg / 353oz - 230VAC or 110VAC - max 55W - outdoor use on request

°poirot

Curled as a curly moustache, is the corpus of the light element, called “Poirot”, with whom this moustache is associated the best. Available as hanging lamp or two types of wall lamp and in several colors. With a lumen output of over 2500lm for the wall version and over 7000lm for the hanging version, the Poirot is perfect for situations where a lot of light is required.

Design by Bart Lens

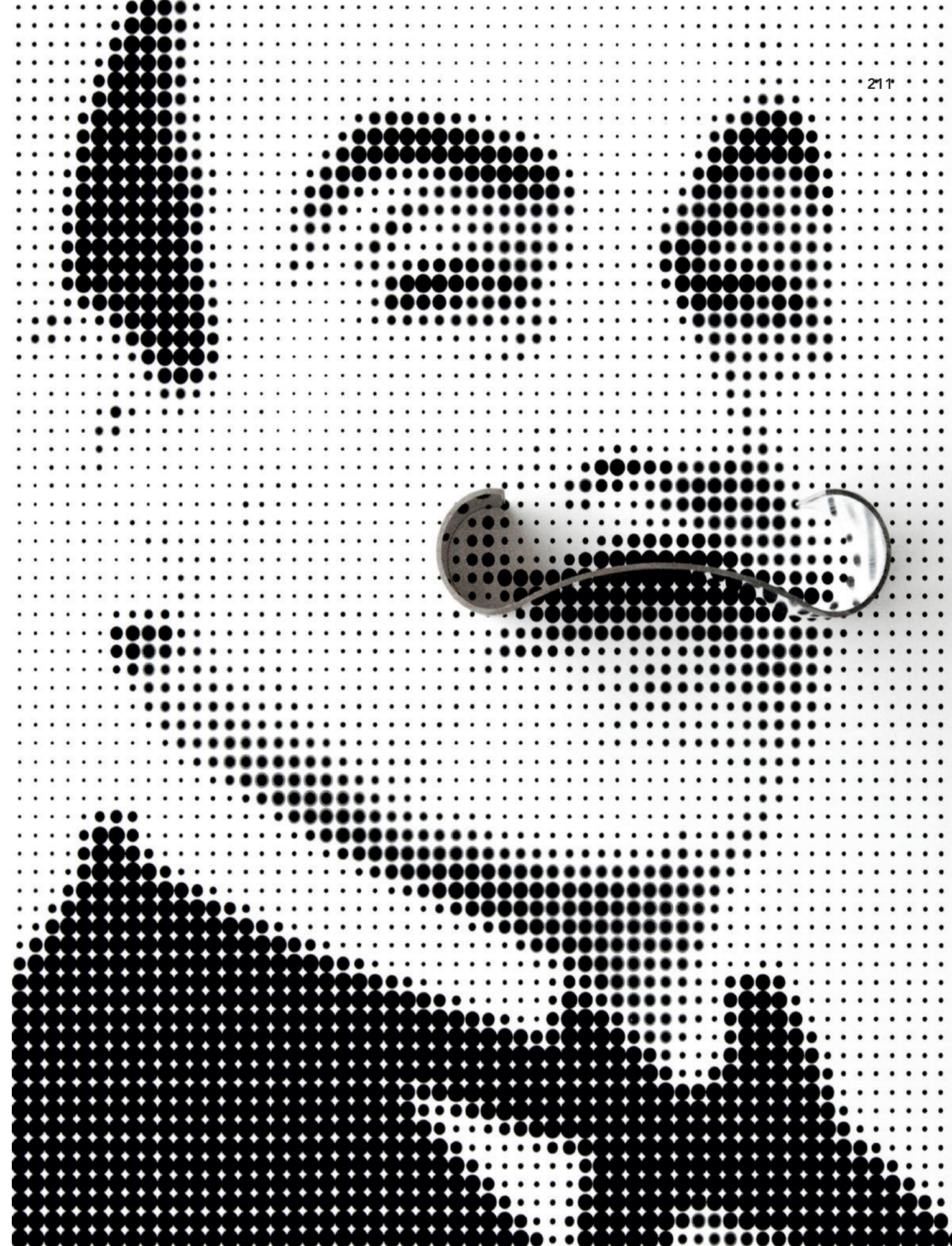





POIROT



652
25.66

MAGNETIC
POIROT

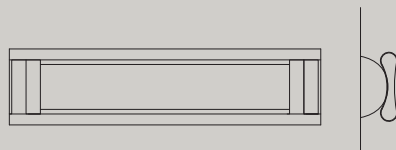

652
25.66

105
4.13

PENDANT
POIROT

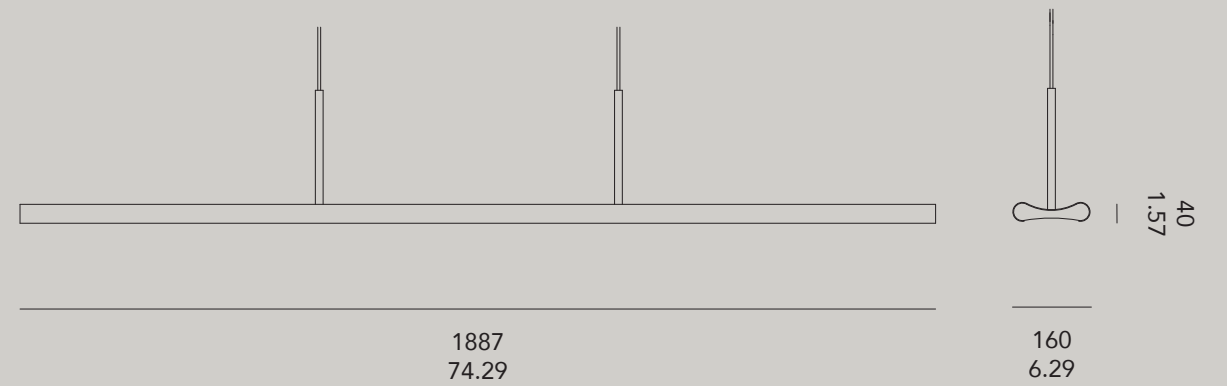

1887
74.29

160
6.29

40
1.57

°poirot



| | |
|----------------------|---|
| PRT.WH.30 | white |
| PRT.RAL.30 | other RAL colors |
| PRT.MG.WH.30 | magnetic wall version - white - incl. wall bracket |
| PRT.MG.RAL.30 | magnetic wall version, custom RAL color, incl. wall bracket |
| PRT.PD.WH.30 | pendant version - white |
| PRT.PD.RAL.30 | pendant version - custom RAL color |

material: painted aluminium - single: 1,4 kg - 50 oz / 16W - 1140lm - pendant: 4,3 kg - 152 oz / 102W - 4320lm
230VAC - 3000K LED tube T8

°de light ful

°de light ful is a hanging tubular light fixture with integrated LED light. With a light source on top and bottom, you can create your own atmosphere. The use of this lighting-object will give an extra dimension to your room. You can choose for a version with solid colors or for a version with dynamic colors controllable by DMX. The RGBW LEDs give you the opportunity to choose any desired color.

Design by Eden Design



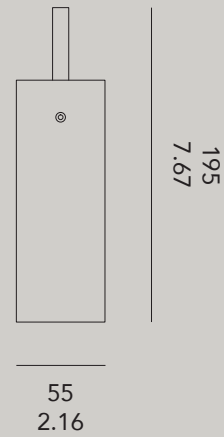

**DLF55.C.D.T.B**

de light ful fixture - 100 mm



| | | |
|------------|---|--|
| Color body | BK WH | black matt ral 9011 white matt ral 9016 |
| Diffuser | F O10 O20 O30 O40 | frosted 10° optic 20° optic 30° optic 40° optic |
| Top led | WW2 | 3000K 800 lm |
| Bottom led | WW2 R G B Y M C RGBW | 3000K 800 lm red green blue yellow magenta cyan five channel DMX - RGBW |

material: painted aluminium - weight: 350 gr / 12,3 oz - 24VDC - max 18W for WHI/CLR, max 15W for DMX version

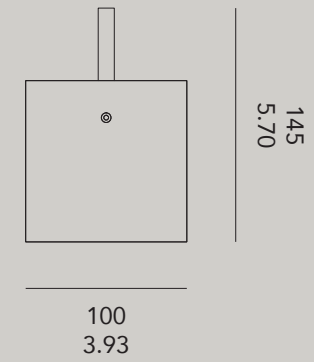
**DLF100.C.T.B**

de light ful fixture - 100 mm - frosted diffusers

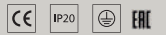

| | | |
|------------|---|---|
| Color body | BK WH | black matt ral 9011 white matt ral 9016 |
| Top led | WW2 | 3000K 800 lm |
| Bottom led | WW2 R G B Y M C RGBW | 3000K red green blue yellow magenta cyan five channel DMX - RGBW |

Accessories

- PS.24.16** power supply 24DVC 16W for powering one fixture (WHI/CLR version)
2 pieces required: each led one driver
- PS.24.XXX** power supply 24DVC ...W for powering several fixtures (see page 76)
- DLF.ADR.XXX** pre-programmed DMX address
- DLF.ROSE.W** rose ceiling white, diameter 50 mm
- DLF.ROSE.B** rose ceiling black, diameter 50 mm

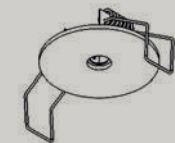

material: painted aluminium - weight: 450 gr / 15,9 oz - 24VDC - max. 18W for WHI/CLR, max 22W for DMX version

Product photography & photo editing /
Philippe Van Gelooven & etremoderne.be

Graphic design /etremoderne.be

Paper / FSC-C007342 en PEFC certified

First edition

© Eden Design, 2017, Genk, Belgium